

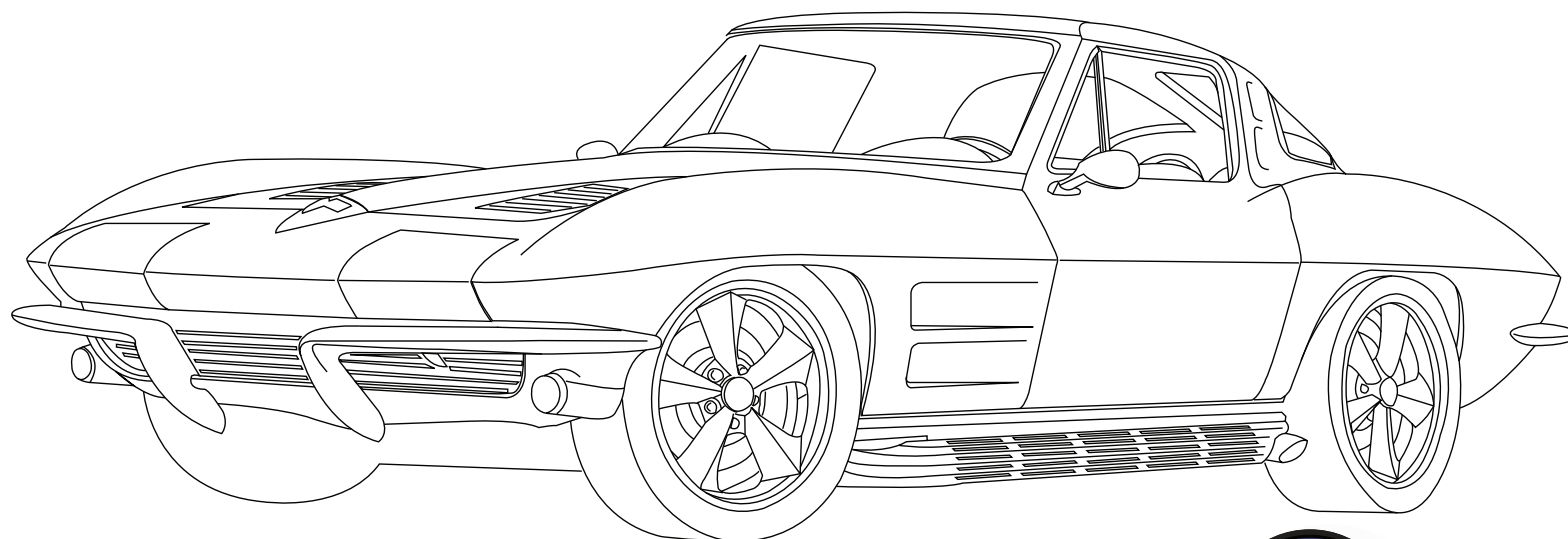

WARNING:

Validate the kit contents with the component list included on this page, before proceeding. This kit is intended to be used in a modified vehicle. Please read this page thoroughly and be sure that you understand everything explained on it prior to opening any of the enclosed packages, or before attempting to install any of the components. Once this kit has been opened or a component installed, the kit is not returnable.

1. This upgraded AAW wiring system should typically be used in a MODIFIED application only. This kit is not designed for use on a stock Corvette.
2. This kit includes the wiring to support the use of a factory heater only system and/or aftermarket heater and A/C systems. This kit **does not** include the wiring for the factory original A/C system.
3. This kit requires the use of a high current self-exciting 1-wire, "SI" series, or other style internally regulated alternator. An adapter may be necessary in some applications. The use of stock alternator is **NOT** supported.
4. This kit requires the use of an original, factory headlight switch nut to mount the new, upgraded headlight switch. This nut is not provided in the kit so, if the original nut is not available, a replacement will be required. The GM part number for this nut is h and it is available from various Corvette parts suppliers.
5. This kit **DOES NOT** support the use of an ammeter. All AAW kits are engineered to supply the optimum charge to the battery. To achieve this performance, we route our 6ga. charge wire directly from the alternator output charge terminal to the starter battery terminal. Due to the path of the charge being altered from the stock configuration, the gauge can no longer see a charge vs. a discharge, so it may not work properly. Most stock alternator current outputs were rated at a maximum of about 37-60 amps. Modified cars being built today typically utilize a 100 amp or higher output alternator. With these higher current units, ammeters, generally speaking, become a safety hazard. Ammeters are usually wired in parallel to the charging circuit, are typically unfused, and can short very easily causing a fire. This wiring system has been designed to work with a voltmeter.
6. This kit **IS NOT** set up with a resistance wire for a standard, points type ignition system. It is wired with a full 12-volt primary ignition feed that is hot in the crank and run positions. Our system will support HEI, MSD, other electronic ignition systems, as well as most all computerized Fuel Injection systems. If you wish to run a points type system, there are illustrations on the engine connection pages to do so. Primary ignition voltage in the cranking position is handled via a full 12 volt bypass wire that is routed from the starter "R" terminals to the positive side on the coil. Extra parts (ballast resistor) that are not included in this kit will be required to complete that type of operation.



510612 - Classic Update Series Kit 1963-67 Chevrolet Corvette

This kit contains the following components:

Bag	Part Number	Description	Quantity
	500042	Floor Dimmer Switch	1
	500332	Headlight Switch	1
	500674	Ignition Switch Lock Cyl. & Keys	1
	510632	Ignition Switch	1
	500919	Practice Terminal Crimping Set	1
	510145	Fuse, Relay, and Flasher kit	1
G	510890	Dash Harness kit	1
H	510614	Instrument Cluster wiring kit	1
J	510908	Engine Wiring Kit	1
L	510909	Front Light Wiring kit	1
M	510619	Rear Body Wiring kit	1
N	510620	Headlight Extension Wiring kit	1
V	510730	VSS Extension Lead Wires	1
Z	510476	Alternator and Main Power kit	1
	92971437	Firewall Template	1
	92973565	Instruction set	1

Validate the kit contents with this component list. If there are any discrepancies with incorrect or missing parts, stop your installation and notify the supplier you purchased the kit from before proceeding.



1963-67 Corvette
 Classic Update Series
510612

© COPYRIGHT 2004 American Autowire / Factory-Fit
 Used with express permission of
 American Autowire / Factory-Fit
 92973565 Rev 2.1 12/17/2024

START HERE !

PLEASE READ THIS BEFORE STARTING INSTALLATION !

This wiring kit is designed for ease of installation. Please read the guidelines below, BEFORE STARTING your installation, to guarantee a successful job. Use an appropriate crimping tool, which folds the wings of the open barrel terminals down into the wire, as shown on this page. If you use our crimping tools and correctly crimp the included terminals, soldering is not necessary. If you are unsure about a particular crimp, soldering is recommended. Our factory crimped terminations are installed by GM approved five ton presses, and soldering these terminations is not necessary.



AAW offers a great terminal crimping video entitled "Proper Crimping Video". It can be viewed by visiting YouTube.

Type the following address into your web browser, to go directly to the video:
www.youtube.com/watch?v=JAgEDoVI-co

Youtube Channel:
www.youtube.com/user/WiringHarness



Factory Assembly Manuals

- 1963 p/n 36337
- 1964 p/n 36338
- 1965 p/n 36339
- 1966 p/n 36340
- 1967 p/n 36341

The terminals that we supply in our kits, utilize what is known as an F crimp. The F crimp, in a cross section, will look like the illustration below, when done correctly.

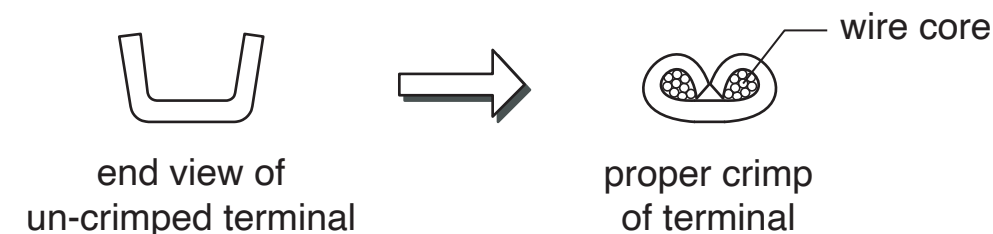

We carry the following crimping hand tools, to help with your terminal crimping. These hand tools are available, for purchase or rental.

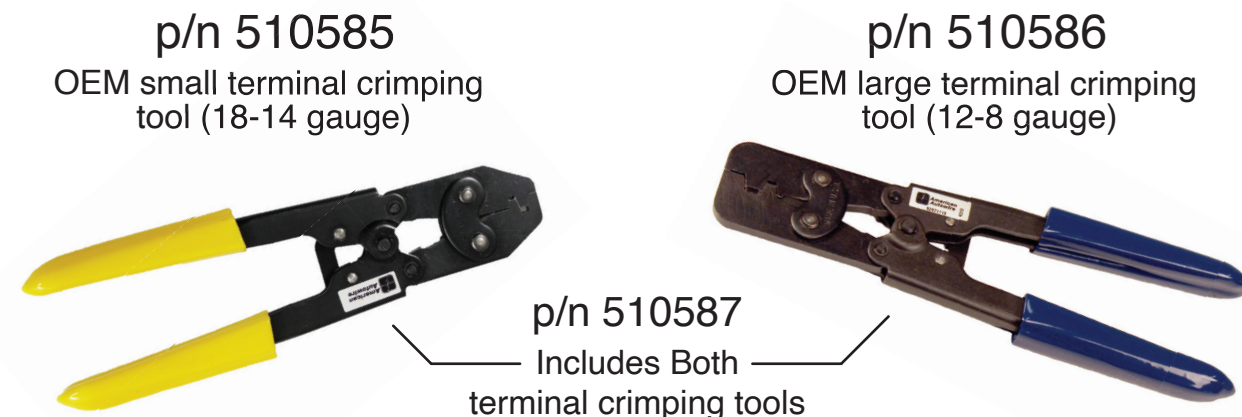

We carry many accessories for your 1963-67 Corvette.



Full vehicle grounding kit
p/n 500717

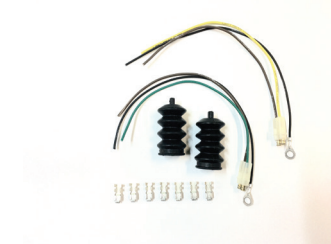

Optional Third Tail Light Kit
p/n 510679



64-65 Corvette Rear Mounted Blower Kit
p/n 510681

If you have any questions concerning this or any of our products, please feel free to call us at 1-856-933-0801.



1963-67 Corvette
Classic Update Series
510612 92973565 Rev 2.1 12/17/2024

STEP 1: DISCONNECT YOUR BATTERY:

Disconnect the battery, before installing the wiring kit, to prevent any accidental shorting caused by loose bare wire ends.

STEP 2: START INSTALLING KIT:

This kit is broken down into individual sections, that are identified by a letter printed on the enclosed sheets, visible through each bag. The order of installation and the pages with their installation instructions, are shown below:

Table of Contents:

Bags: Pages: Sections:

- G** 4 - 9 **Dash Harness** - This is the main harness in the kit and contains:
- Starter solenoid connections.
 - Wiper motor connections.
 - Brake light switch connection.
 - Neutral safety switch connection.
 - Door jamb switches.
 - Wiper module and switch connections.
 - Defrost module and switch connections.
 - Headlight and fog light connections.
- H** 10 - 14 **Gauge Cluster Harness** - This Harness contains:
- Gauge connections for aftermarket and factory gauges.
- M** 15 - 19 **Rear Body Harness** - This Harness contains:
- Tail light, turn signal, reverse light, and running light connections.
 - Hatch connections; third brake light, license plate lights, and rear defroster connections.
 - Fuel pump connections
 - Brake fluid level wiring.
- L** 20 - 22 **Front Light Harness** - This Harness contains:
- Headlight, turn signal, running light connections.
 - Fog lamp wiring.
 - Windshield washer connection.
 - Electric fan relay trigger.
 - Electric Choke.
- J** 23 - 25 **Engine Harness** - This Harness contains:
- Temperature, oil pressure, tachometer wiring.
 - Ignition system / ECU power.
 - Alternator connections.



www.americanautowire.com 856-933-0801

PLEASE READ THIS HELPFUL INSTALLATION TIP, BEFORE GOING ANY FURTHER!

Prior to installing the Dash/Main harness in your dashboard, plug all of the fuses (see detailed picture below), Horn Relay, Hazard Flasher and Turn Flasher (see detailed picture below), into this harness.

Fuse label on inside
of Fuse Box lid

Batt - Spare 30A - BAT	1	9	Wiper 20A - ACC
Clock/Radio 15A - BAT	2	10	Heat/AC 30A - ACC
Power Seat 30A - BAT	3	11	Radio 10A - ACC
Park Lights 15A - BAT	4	12	Engine Fan 30A - ACC
Power Locks 15A - BAT	5	13	Turn 15A - IGN
Stop/Courtesy 15A - BAT	6	14	Gauges, B/U 10A - IGN
Hazard 15A - BAT	7	15	Elec. Choke 15A - IGN
Pwr. Window 30A - IGN	8	16	Fuel Pump 20A - IGN

Fuse Values and
Locations

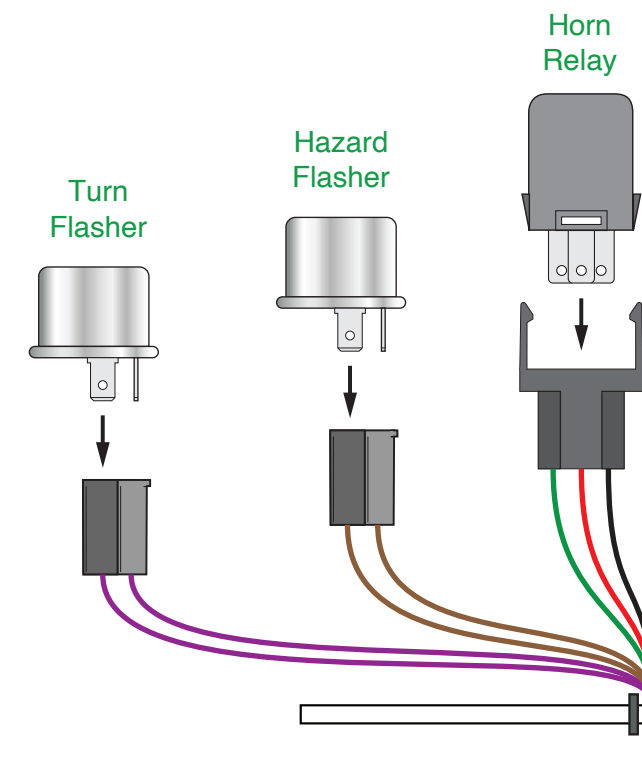
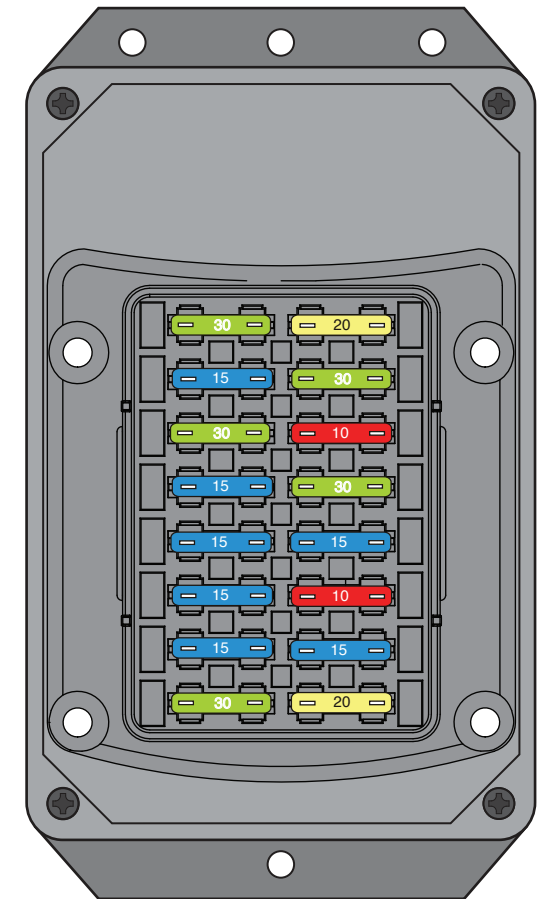

1963-67 Corvette
Classic Update Series
510612 92973565 Rev 2.1 12/17/2024

Dash/Main harness installation instructions:

Shown below, are the supplied misc. terminals, plastic connector bodies, hardware, jumpers and extensions that will be used to complete your Dash/Main harness connections. They are itemized and referred to on this page, just as they are on the following pages of this Dash/Main instruction set.

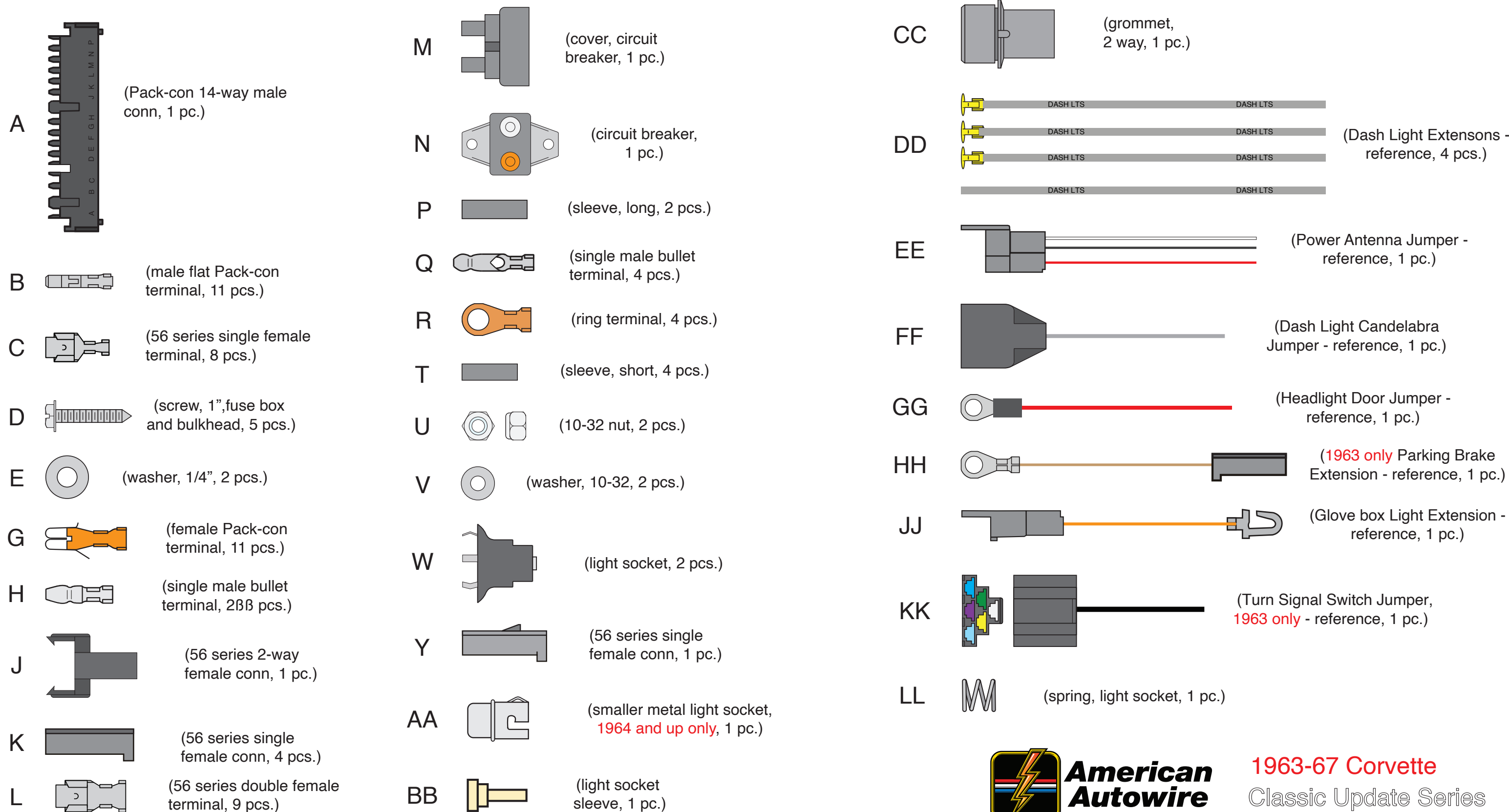

Dash/Main harness installation instructions:

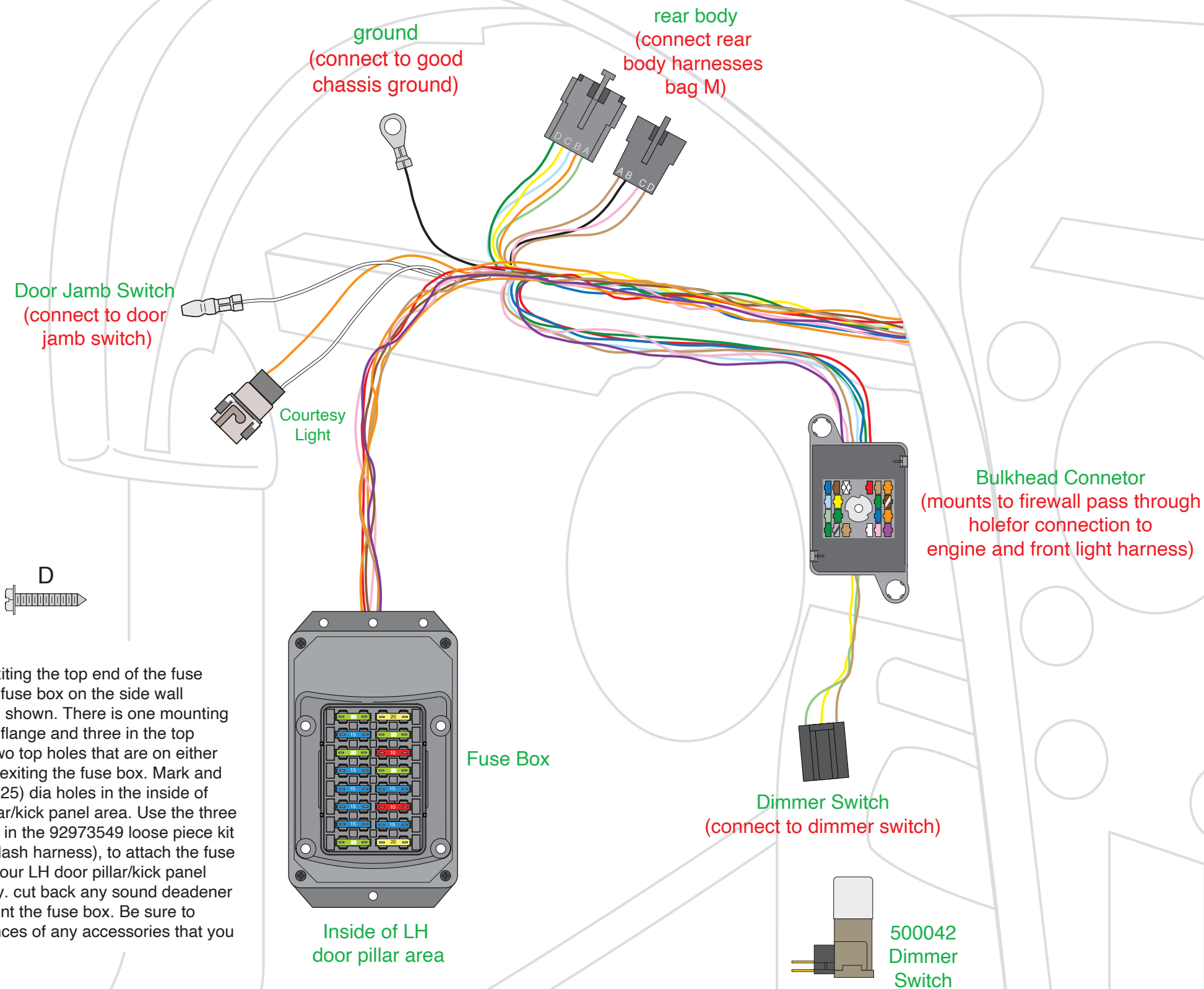

NOTE:

With the wires exiting the top end of the fuse box, position the fuse box on the side wall approximately as shown. There is one mounting hole in the lower flange and three in the top flange; use the two top holes that are on either side of the wires exiting the fuse box. Mark and drill three 1/8" (.125) dia holes in the inside of your LH door pillar/kick panel area. Use the three screws, "item D", in the 92973549 loose piece kit (for the 510890 dash harness), to attach the fuse box to inside of your LH door pillar/kick panel area. If necessary, cut back any sound deadener or carpet, to mount the fuse box. Be sure to check for clearances of any accessories that you might be adding.



**American
Autowire**

www.americanautowire.com 856-933-0801

1963-67 Corvette

Classic Update Series

510612 92973565 Rev 2.1 12/17/2024

Dash/Main harness installation instructions:

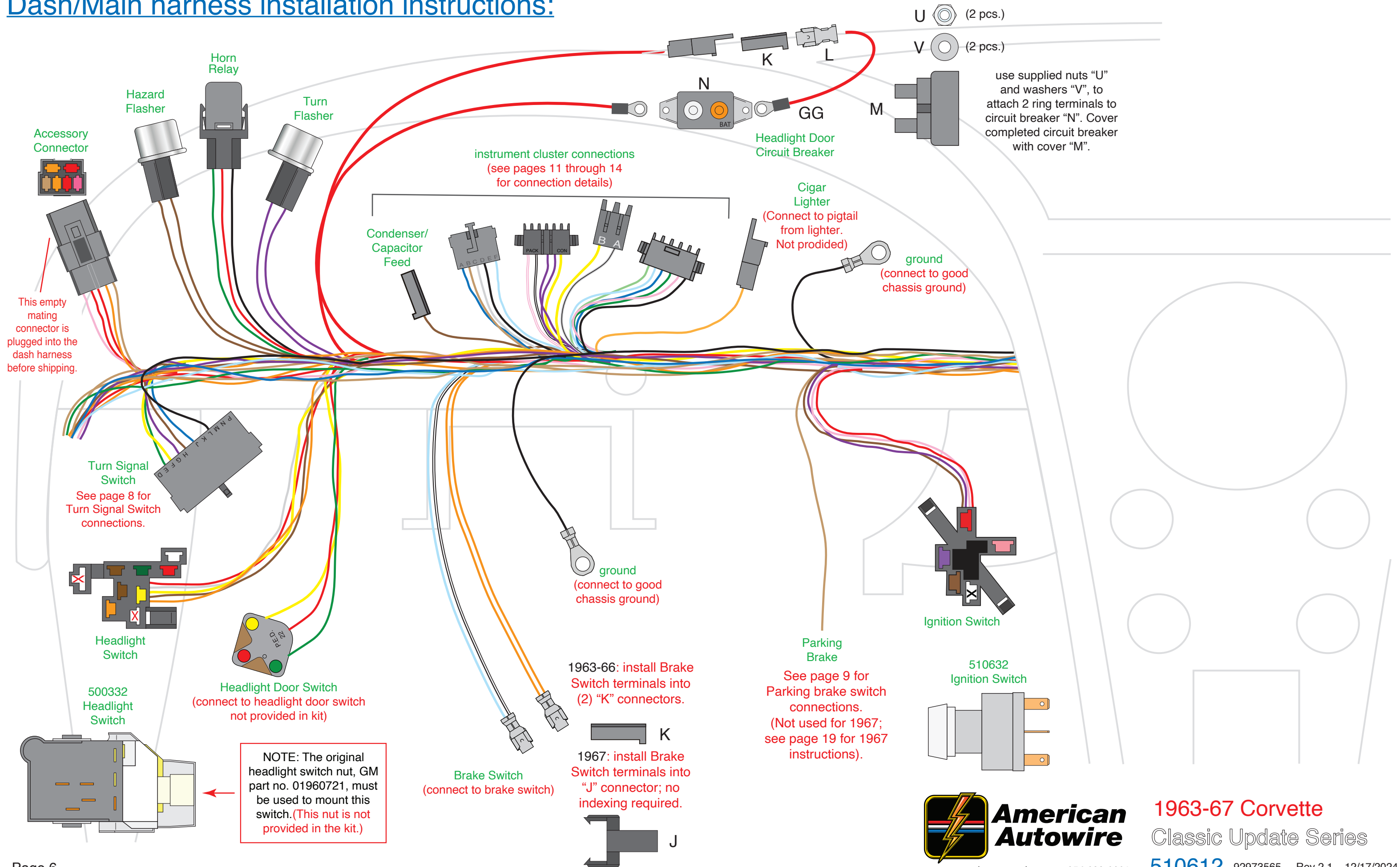

Dash/Main harness installation instructions:

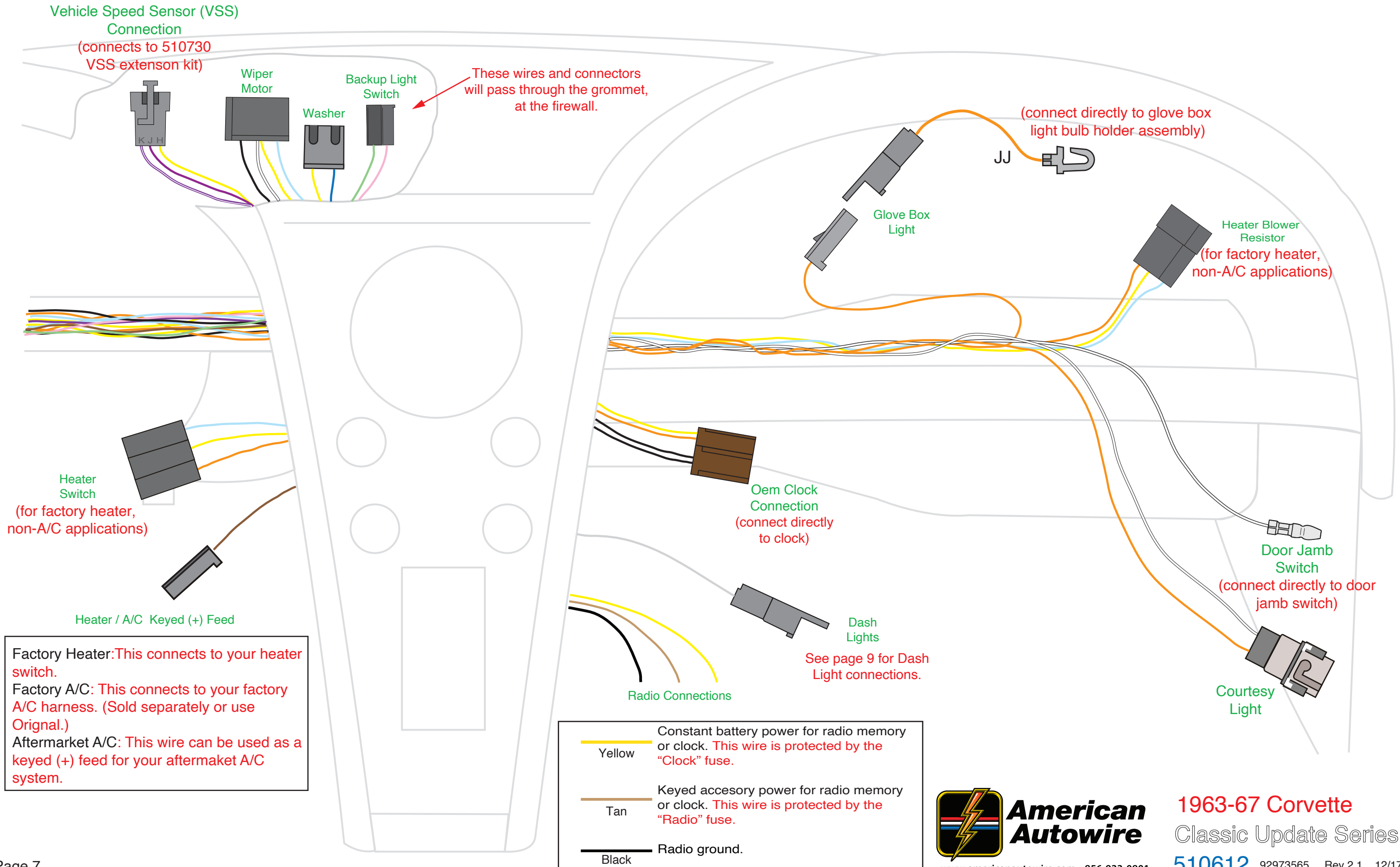

Dash/Main harness installation instructions:

“Table B”

AAW Turn Signal Switch wires to stock 1963-67
Chevrolet Corvette Turn Signal Switch

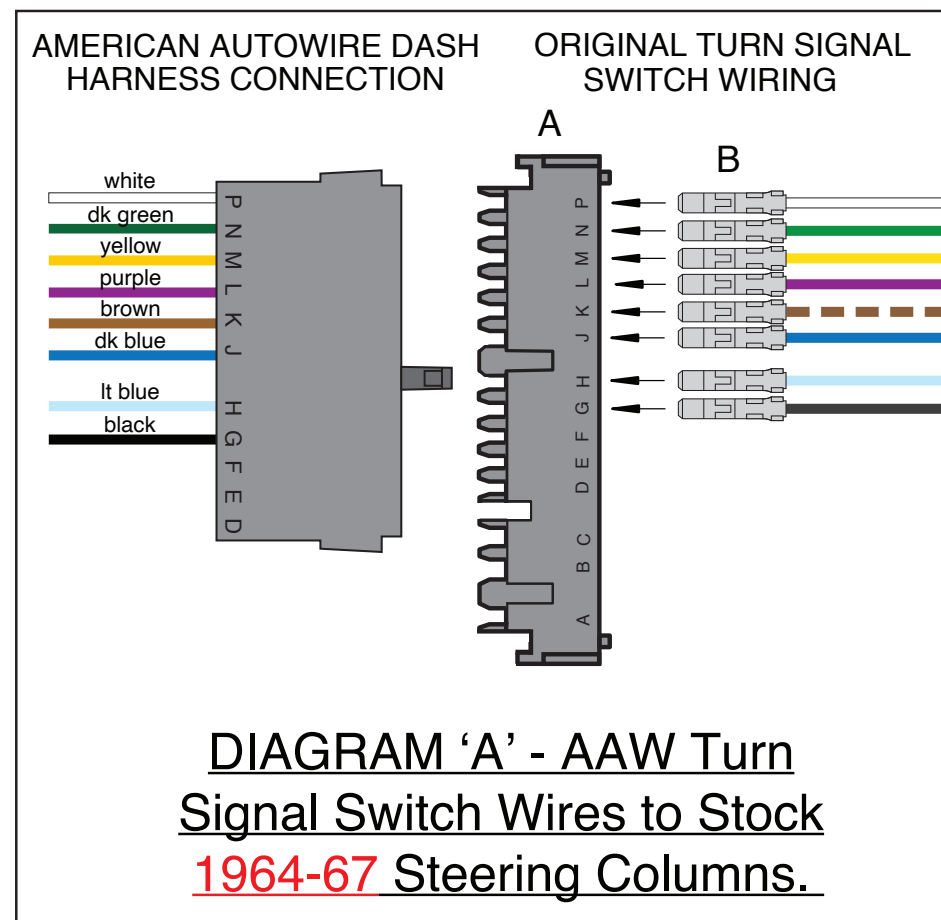
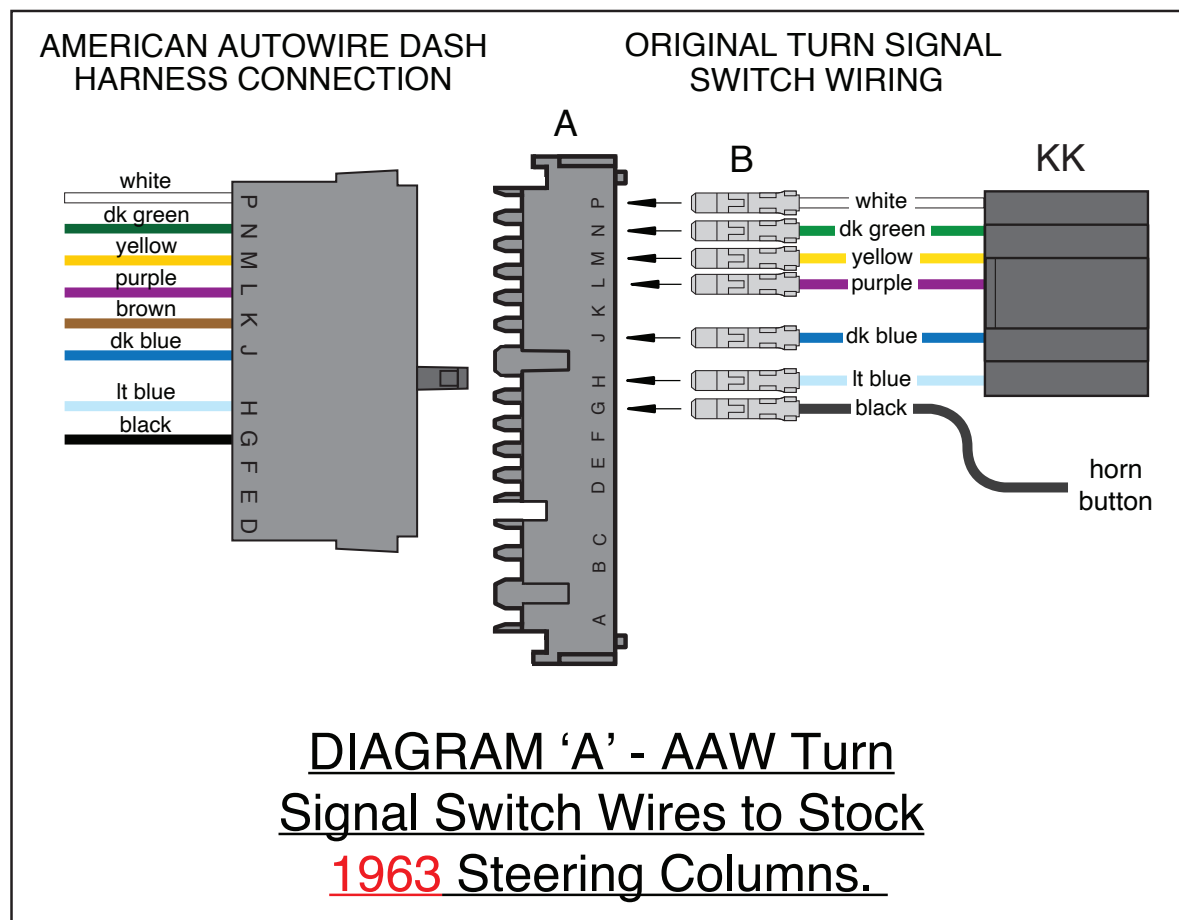

AAW Wire Color	AAW Wire Printing	Connector Cavity AAW
White	Brake SW	P
Dark Green	Right Rear Turn	N
Yellow	Left Rear Turn	M
Purple	Turn Switch Feed	L
Brown	Turn SW – Hazard	K (aftermarket only)
Dark Blue	Right Front Turn	J
Light Blue	Left Front Turn	H
Black	Horn Relay Ground	G
None	None	F
None	None	E
None	None	D

Note: 1963 only: Remove the original Turn Signal Switch Connector and replace it with the AAW 14-way connector “A” and Turn Signal Switch Jumper “KK”. Crimp on terminal “B” to each of the Jumper “KK” wires and plug them into connector “A” (see Parts Kit 92973549).

1964-67 only: Remove the original Turn Signal Switch Connector and replace it with the AAW 14-way connector “A”. Crimp on terminal “B” to each of the original Turn Signal Switch wires and plug them into connector “A” (see Parts Kit 92973549).

Use “Table B” above to align the wires. Also, for all of the vehicles, the Steering Column Horn Button switches ground for the Horn Relay, which then switches power to the Horns, similar to the AAW design.

Accessory Connector

Use the provided 6-way empty connector, which is attached to the 6-way Accessory connector on the Dash Harness, and terminals “C” and “L” to add power wires (not provided) for the following optional systems:

Wire Color	Printing	Fuse #	Fuse Block Cover	Fuse rating	Description
Red	CB-RADIO	7	Hazard	15A	Fused 12 volt BATTERY feed for cruise control (may also be used to feed power to another battery circuit).
Tan	FUEL PUMP	16	Fuel Pump	20A	Fused 12 volt IGNITION feed for fuel pump (may also be used to feed power to another ignition circuit).
Orange	POWER SEATS	3	Pwr Seats	30A	Fused 12 volt BATTERY feed for power seats (may also be used to feed power to another battery circuit).
Red	POWER LOCKS	5	Pwr Locks	15A	Fused 12 volt BATTERY feed for power door locks (may also be used to feed power to another battery circuit).
Pink	POWER WINDOWS	8	Pwr Window	30A	Fused 12 volt ACCESSORY feed for power windows (may also be used to feed power to another accessory circuit).
Orange	12V BATTERY FUSED	1	Batt-Spare	30A	Fused 12 volt BATTERY feed (may also be used to feed power to a battery circuit).



American Autowire

www.americanautowire.com 856-933-0801

1963-67 Corvette

Classic Update Series

510612 92973565 Rev 2.1 12/17/2024

Dash/Main harness installation instructions:

Parking Brake switch wiring:

For 1963:

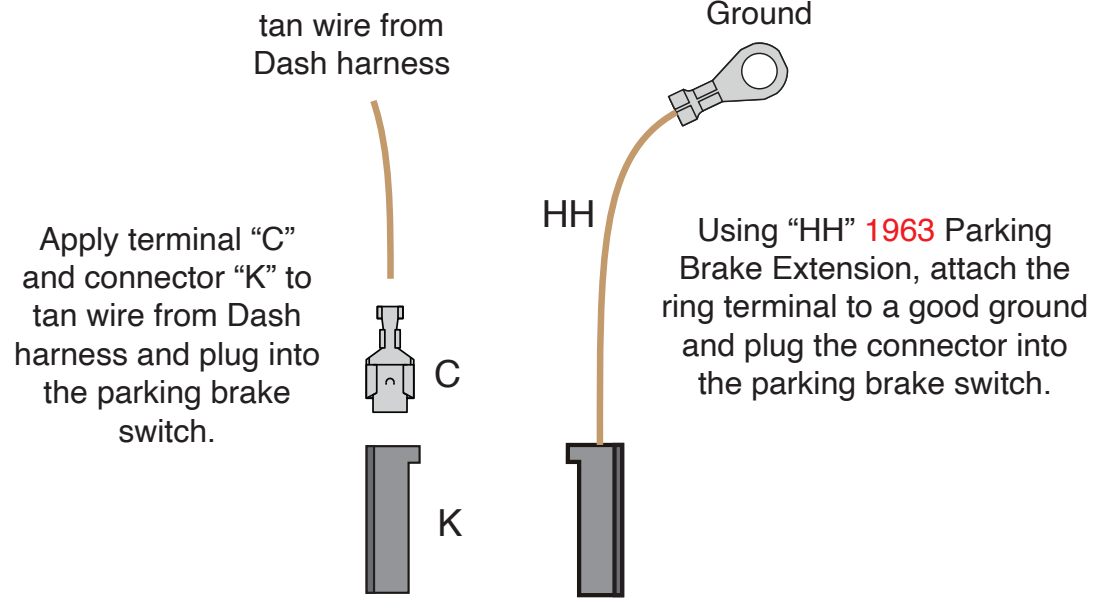

For 1964-66:

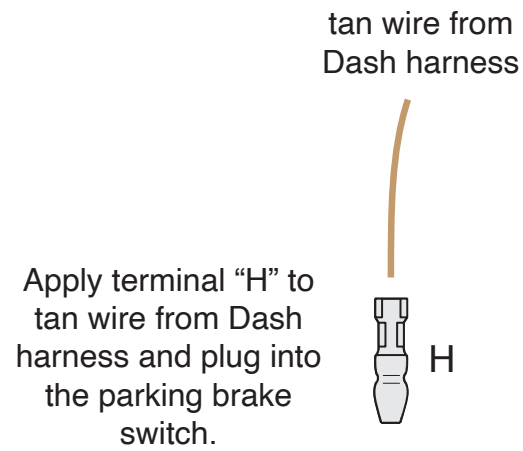

Power Antenna wiring:

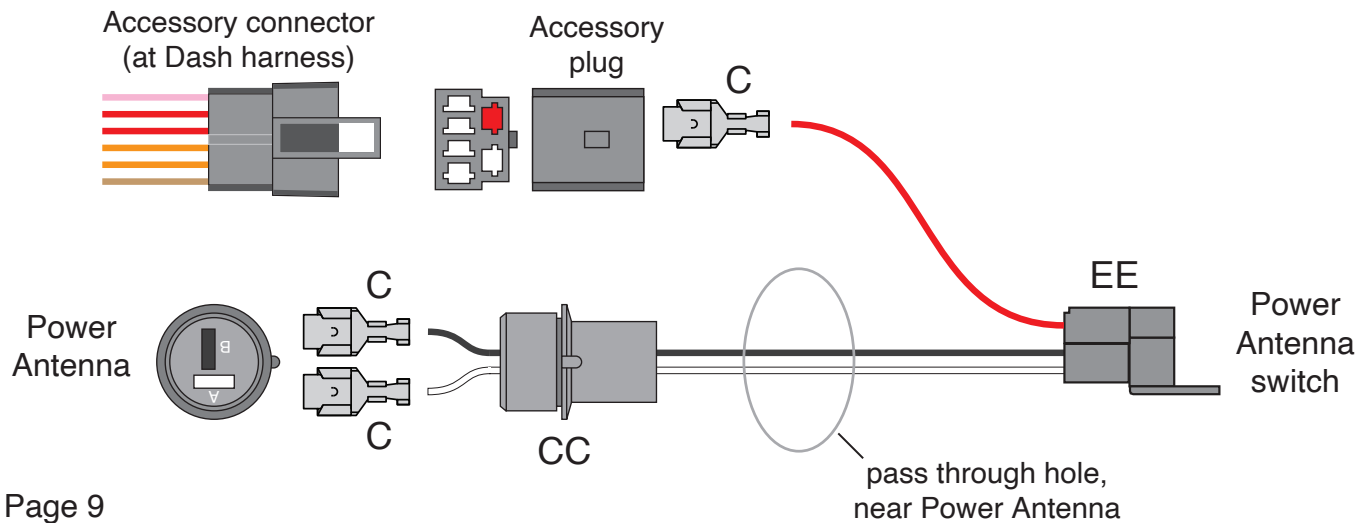

gray wire from Dash harness

Dash Light wiring:

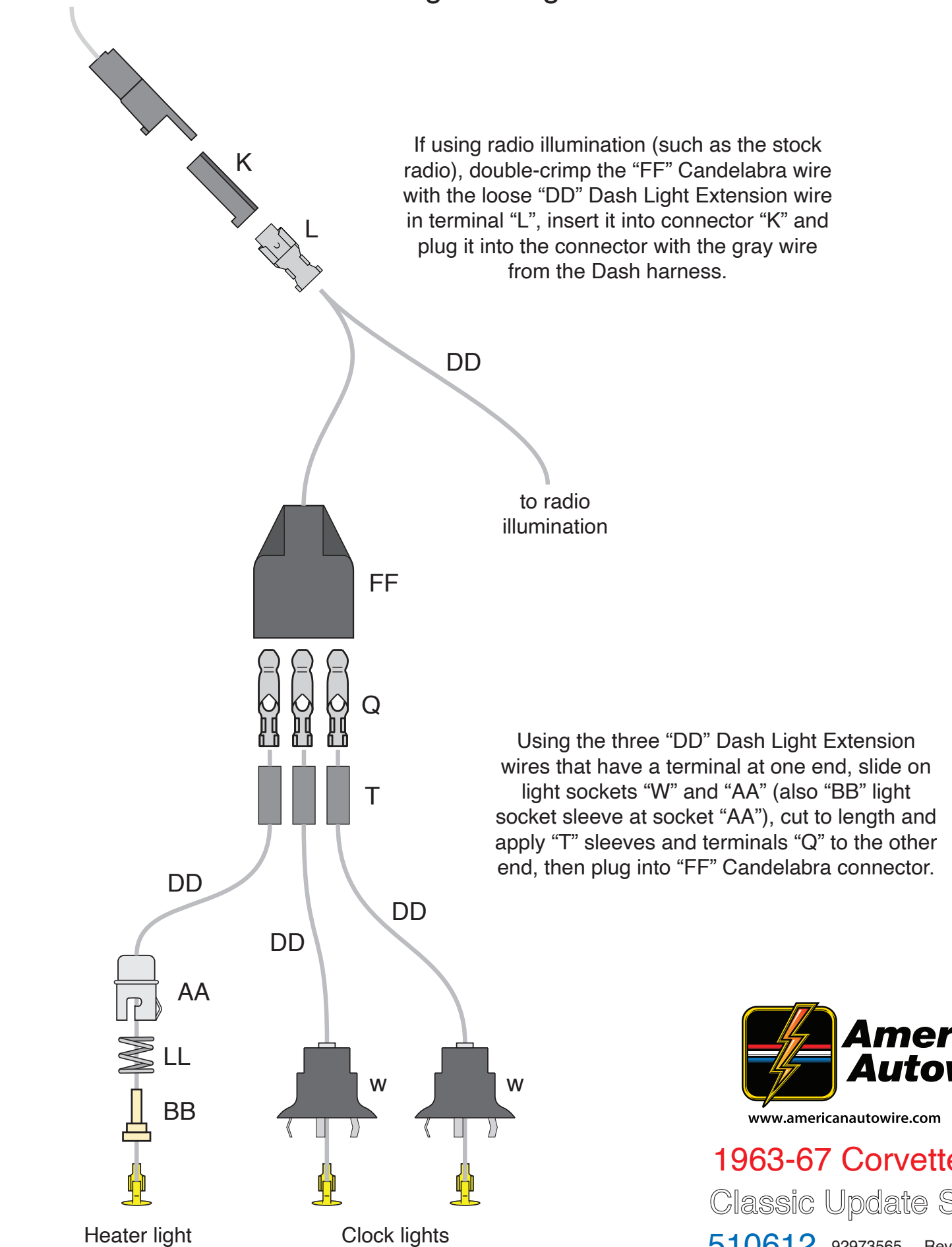









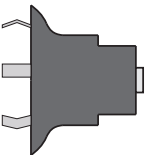



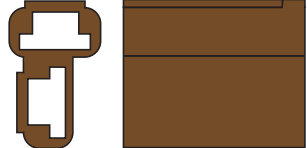

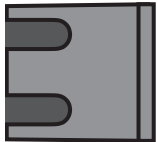
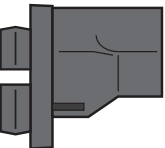
www.americanautowire.com 856-933-0801

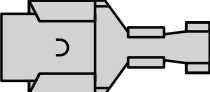
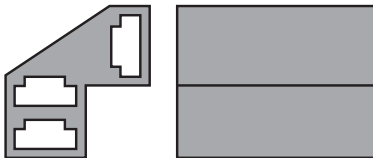
1963-67 Corvette
Classic Update Series
510612 92973565 Rev 2.1 12/17/2024

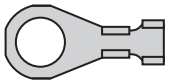
Gauge Cluster harness installation instructions:

Shown below, are the supplied misc. terminals, plastic connector bodies, light sockets and hardware that will be used to complete your Gauge Cluster harness connections. They are itemized and referred to on this page, just as they are on the following pages of this Gauge Cluster instruction set.

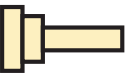
- | | | | | | |
|---|---|---|---|---|---|
| A |  | (light socket, 13 pcs.) | M |  | (spring, smaller metal light socket, 1 pc.) |
| B |  | (spring, plastic light socket, 1 pc.) | N |  | (56 series 2-way female conn, 2 pcs.) |
| C |  | (terminal rivet, 20 pcs.) | P |  | (56 series 2-way female conn, 1 pc.) |
| D |  | (terminal, plastic light socket ground, 2 pcs.) | R |  | (56 series 2-way female conn, 1 pc.) |
| E |  | (plastic light socket, 1 pc.) | T |  | (56 series 1-way female conn, 3 pcs.) |
| F |  | (56 series single female terminal, 8 pcs.) | U |  | (56 series 3-way female conn, 1 pc.) |
| G |  | (splice clip, 6 pcs.) | V |  | (small ring terminal for smaller gauge wire, 1 pc.) |
| H |  | (shrink tubing, 6 pcs.) | | | |
| J |  | (reflector, smaller metal light socket, 1 pc.) | | | |
| K |  | (smaller metal light socket, 1 pc.) | | | |
| L |  | (insert, plastic light socket, 1 pc.) | | | |



1963-67 Corvette
 Classic Update Series
 510612 92973565 Rev 2.1 12/17/2024

How to install lamp sockets and lamp socket terminals.

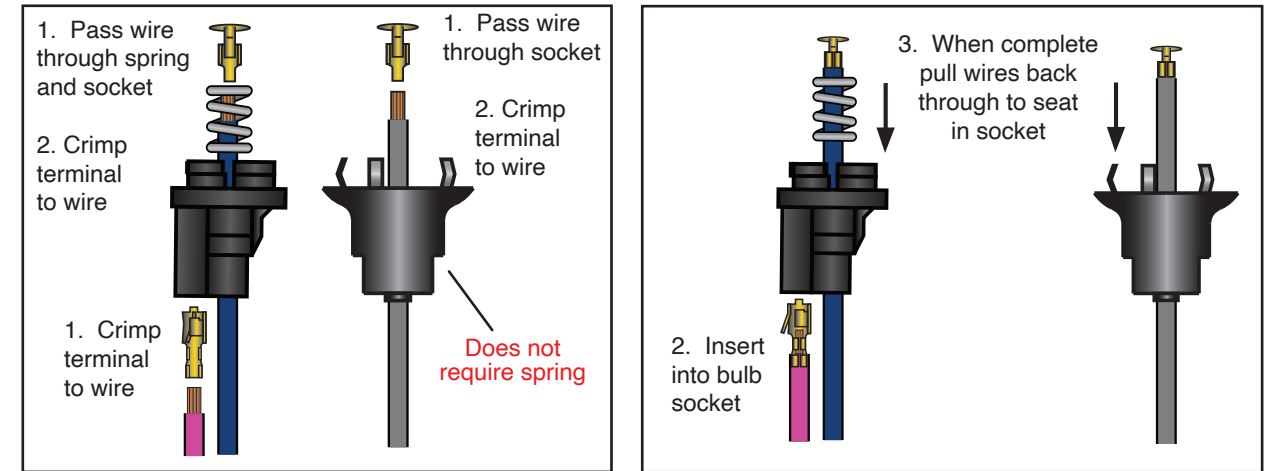

How to use the splice clip to join multiple wires.

Below is just an **EXAMPLE** of how to use the splice clip and shrink tubing; see your specific application on the following pages for actual splice information.

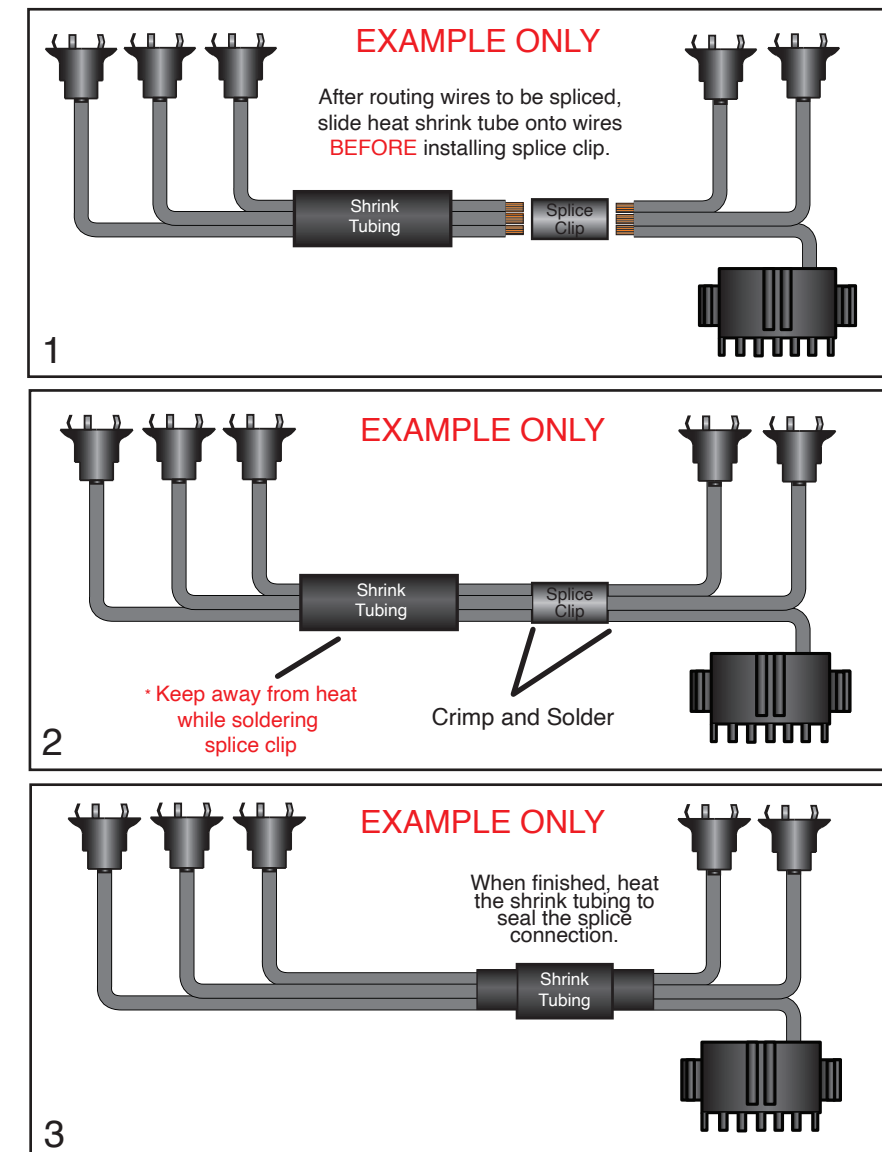

Gauge Cluster harness (aftermarket gauges) installation instructions:

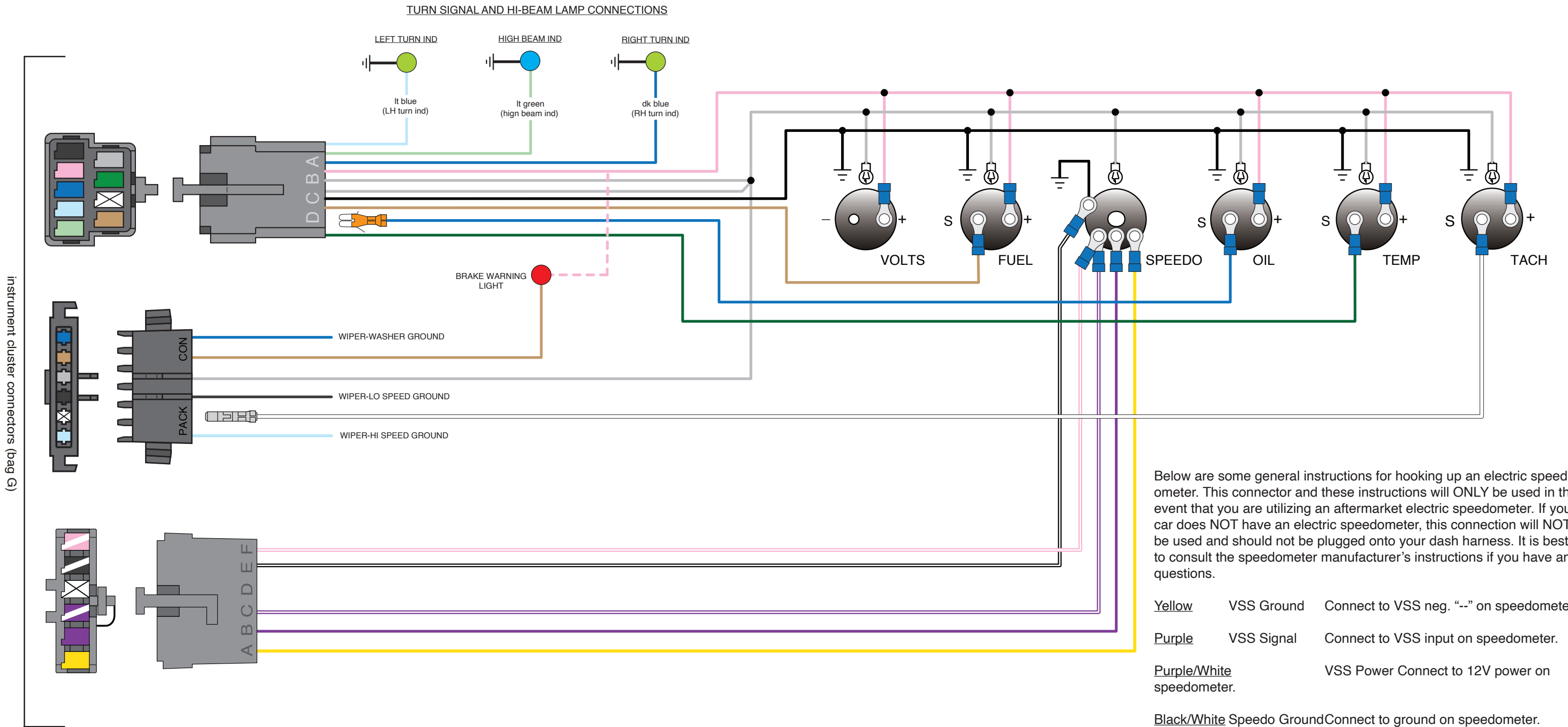

Below are some general instructions for hooking up an electric speedometer. This connector and these instructions will ONLY be used in the event that you are utilizing an aftermarket electric speedometer. If your car does NOT have an electric speedometer, this connection will NOT be used and should not be plugged onto your dash harness. It is best to consult the speedometer manufacturer's instructions if you have any questions.

- Yellow VSS Ground Connect to VSS neg. "--" on speedometer.
- Purple VSS Signal Connect to VSS input on speedometer.
- Purple/White speedometer. VSS Power Connect to 12V power on speedometer.
- Black/White Speedo Ground Connect to ground on speedometer.
- Pink/White Speedo Power Connect to 12v power on speedometer.
 NOTE: This wire will double onto the same stud as the purple/white VSS power wire from above.

See pages 12-14 for factory gauge clusters.



Gauge Cluster harness installation instructions:

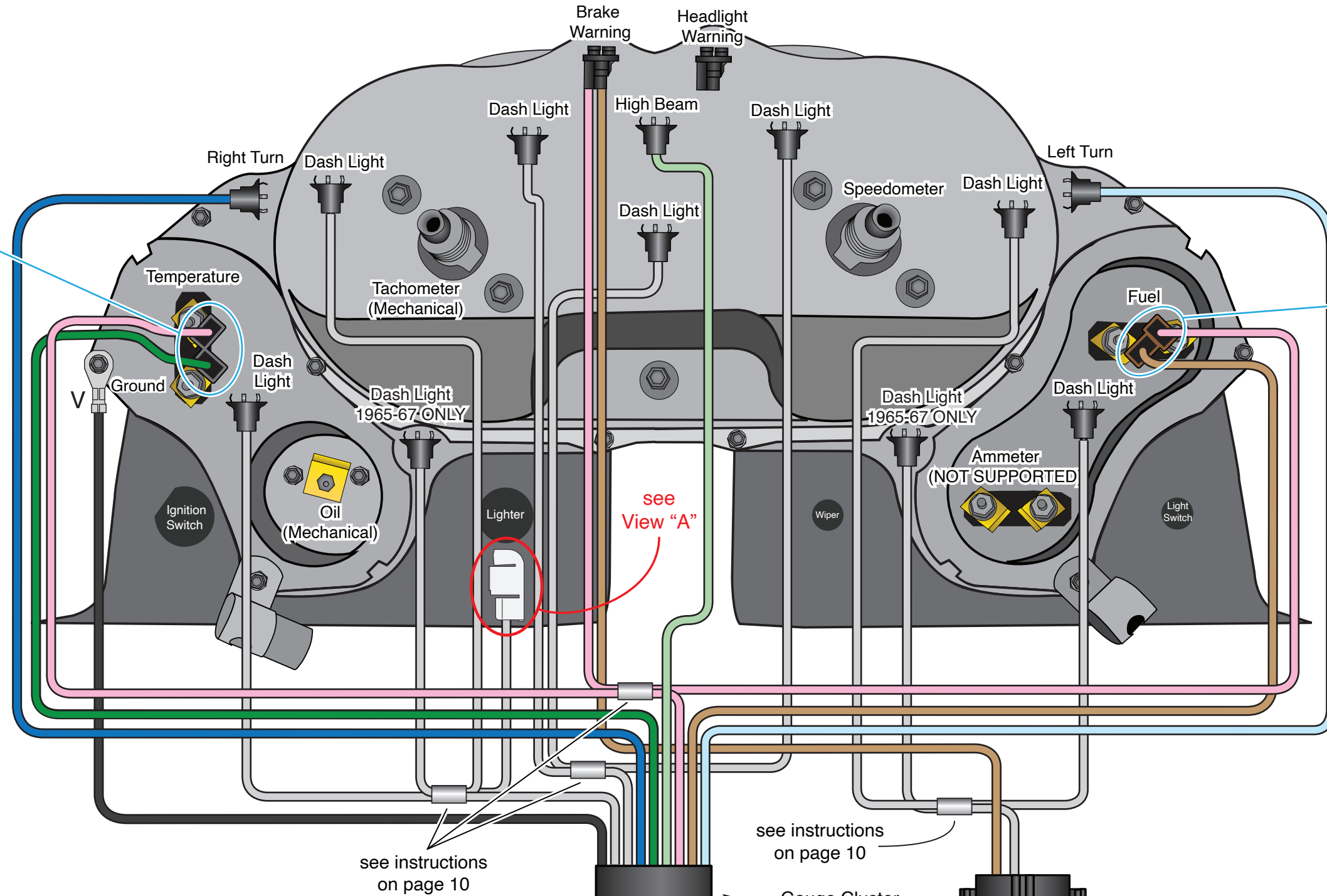
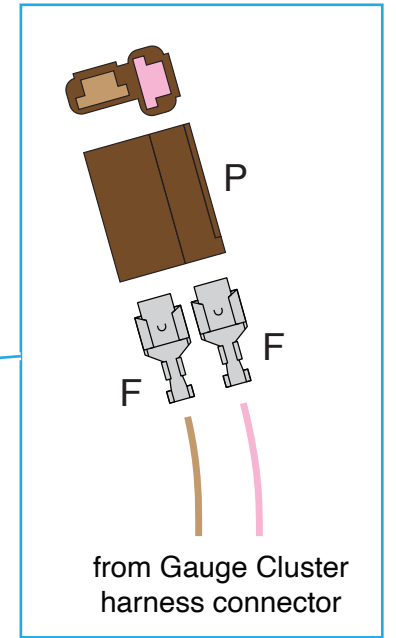
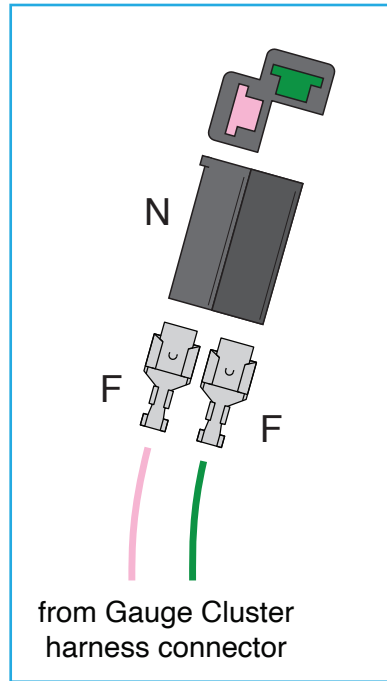

For proper wire locations, refer to "Detail View"

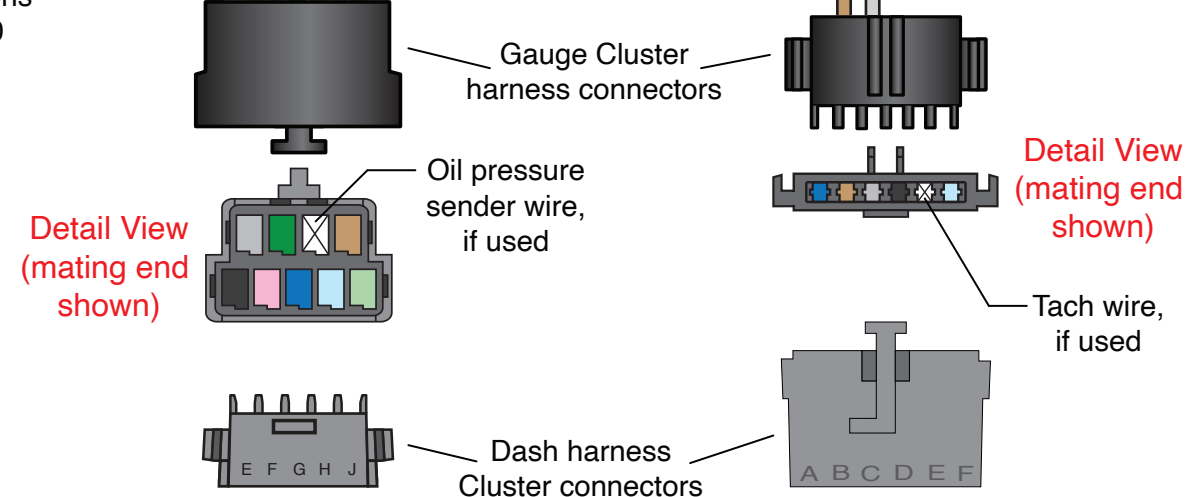
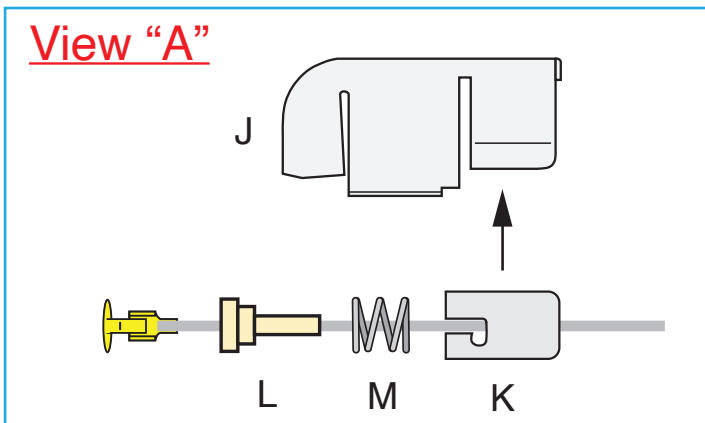

1963-67 Corvette
 Classic Update Series
 510612 92973565 Rev 2.1 12/17/2024

Gauge Cluster harness installation instructions:

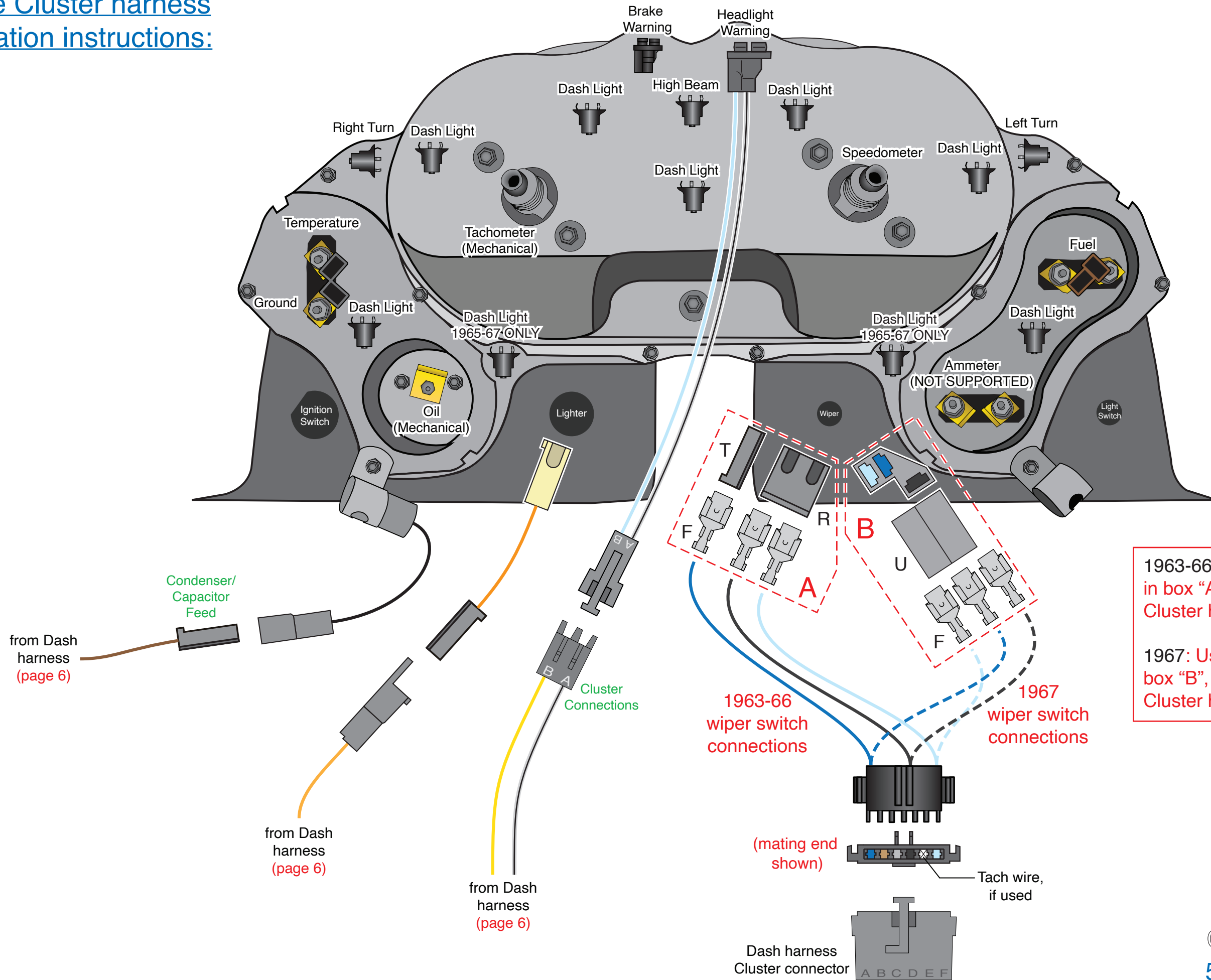

1963-66: Use terminals and connectors in box "A", to the left, to connect Gauge Cluster harness to the wiper switch.

1967: Use terminals and connectors in box "B", to the left, to connect Gauge Cluster harness to the wiper switch.





1963-67 Corvette
 Classic Update Series
510612 92973565 Rev 2.1 12/17/2024

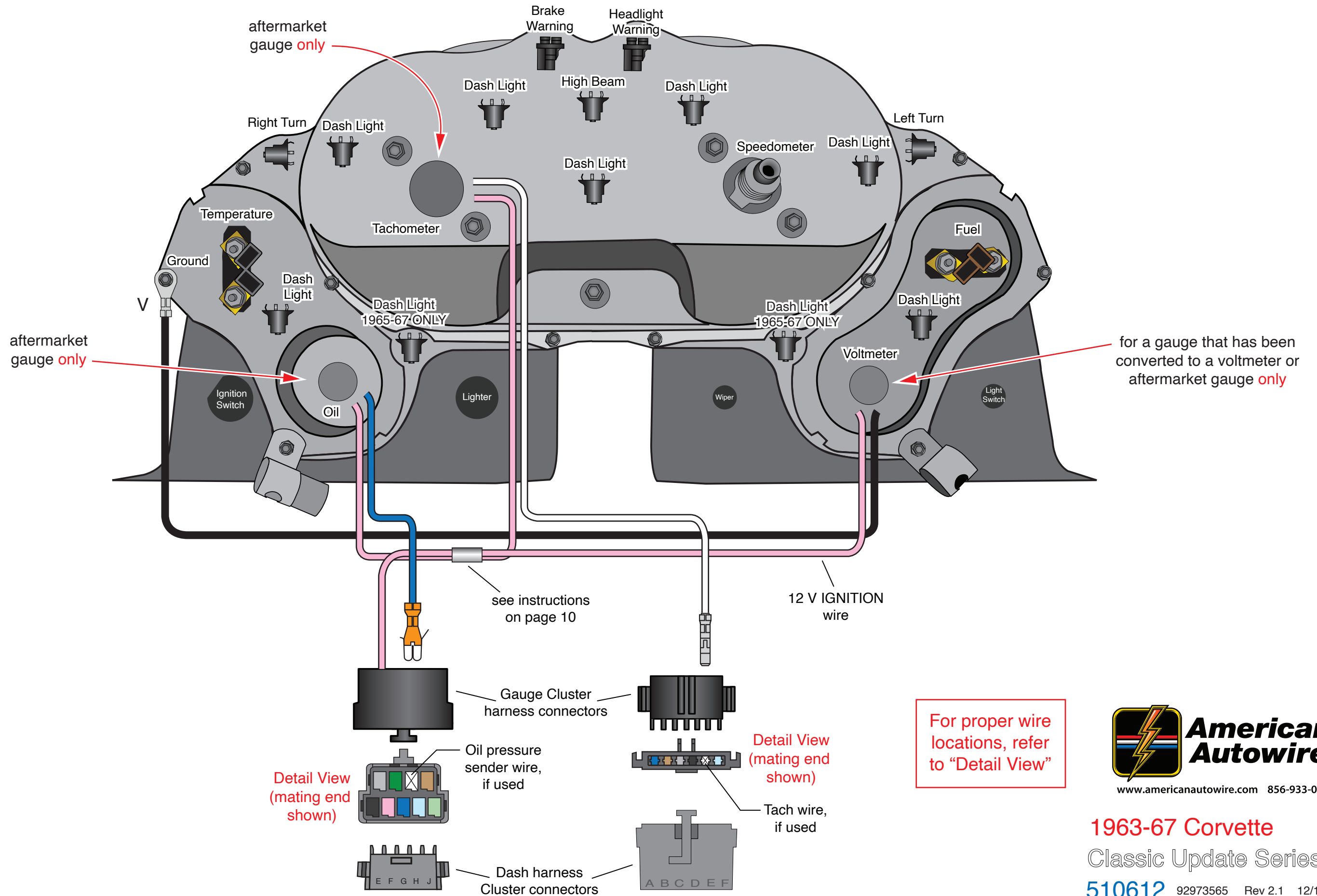



Gauge Cluster harness (optional aftermarket functions) installation instructions:

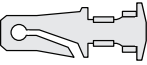
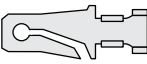
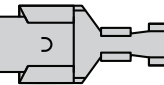
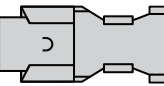
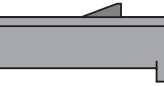
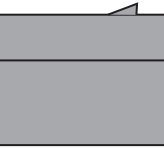
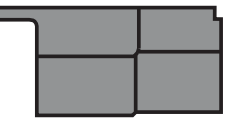
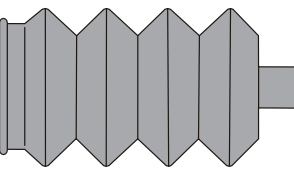

Rear Body harness installation instructions:

Shown below, are the supplied misc. terminals, plastic connector bodies, boots and wire extensions that will be used to complete your Rear Body harness connections. They are itemized and referred to on this page, just as they are on the following pages of this Rear Body instruction set.

- A  (56 series single male terminal, 6 pcs.)
- B  (56 series double male terminal, 3 pcs.)
- C  (56 series single female terminal, 10 pcs.)
- D  (56 series double female terminal, 5 pcs.)
- E  (56 series 1-way female conn, 3 pcs.)
- F  (56 series 2-way female conn, 2 pcs.)
- G  (56 series 2-way male conn, 2 pcs.)
- H  (boot, 6 pcs.)
- J  (bullet terminal, 4 pcs.)

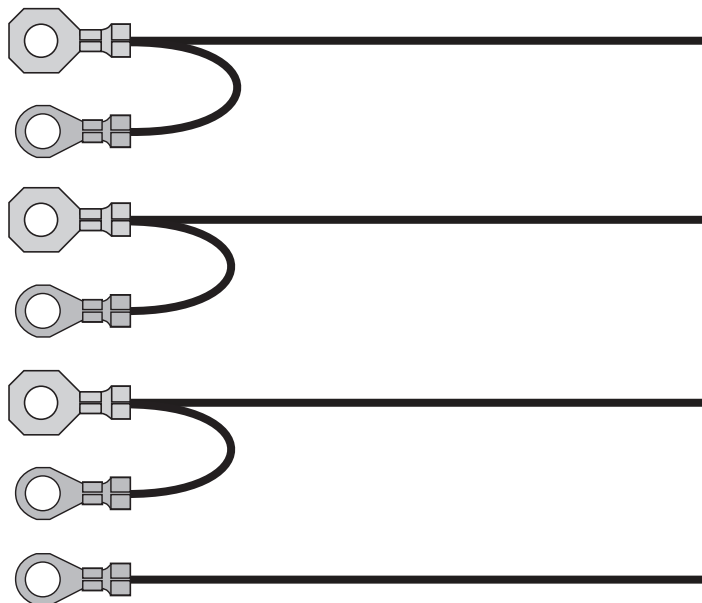
- K  (56 series 1-way male conn, 2 pcs.)
- L  (splice barrel, 1 pc.)
- M  (heat shrink, 1 pc.)
- N  (parking brake wire, 1967 only, - reference, 1 pc.)
- P  (license plate light extension - reference, 1 pc.)
- R  (tail, license and back-up light, ground extensions - reference, 4 pcs.)



1963-65 without back-up lights

Rear Body harness installation instructions:

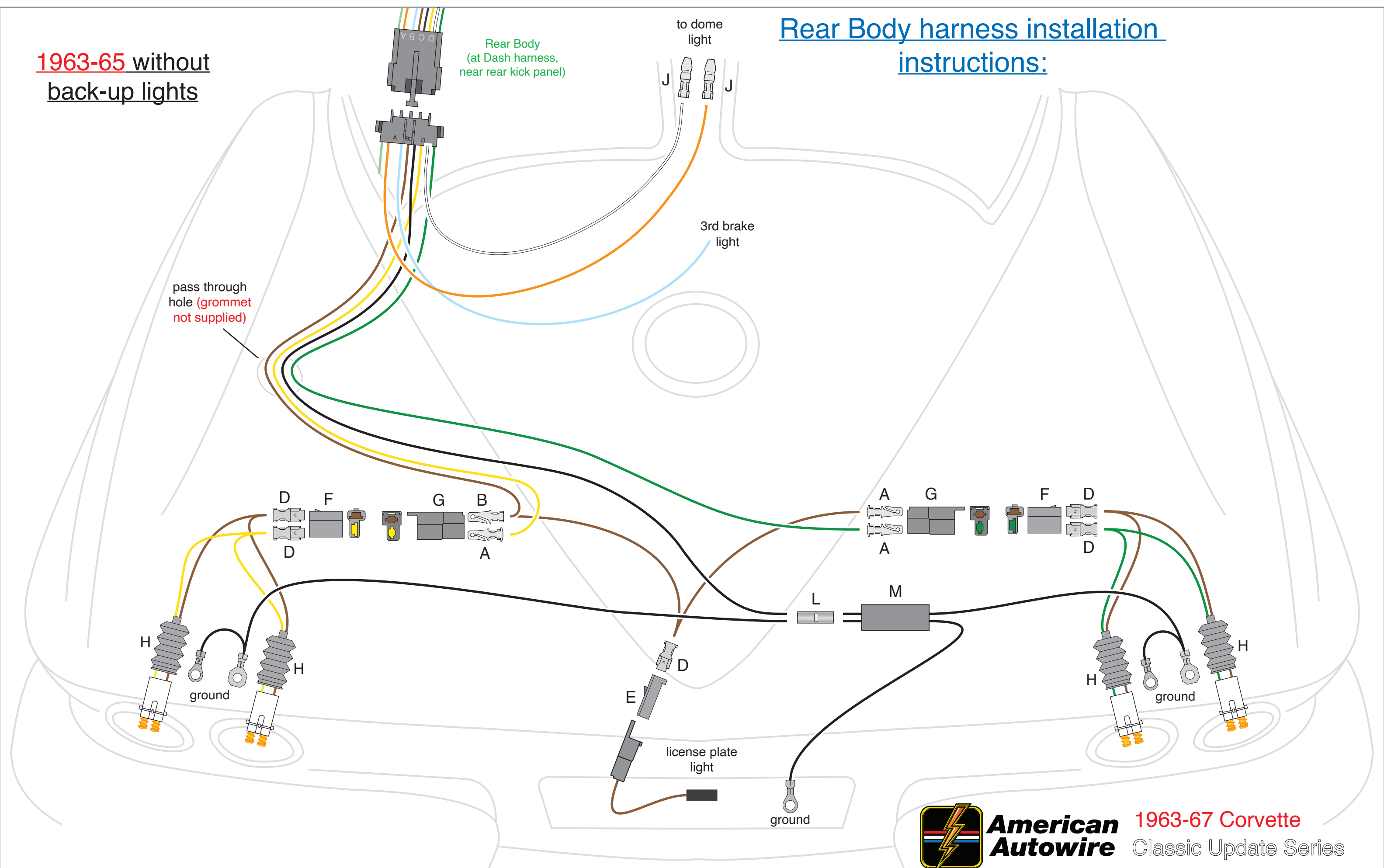

1963-66 with back-up lights

Rear Body harness installation instructions:

pass through hole (grommet not supplied)

Rear Body (at Dash harness, near rear kick panel)

to dome light

3rd brake light

license plate light

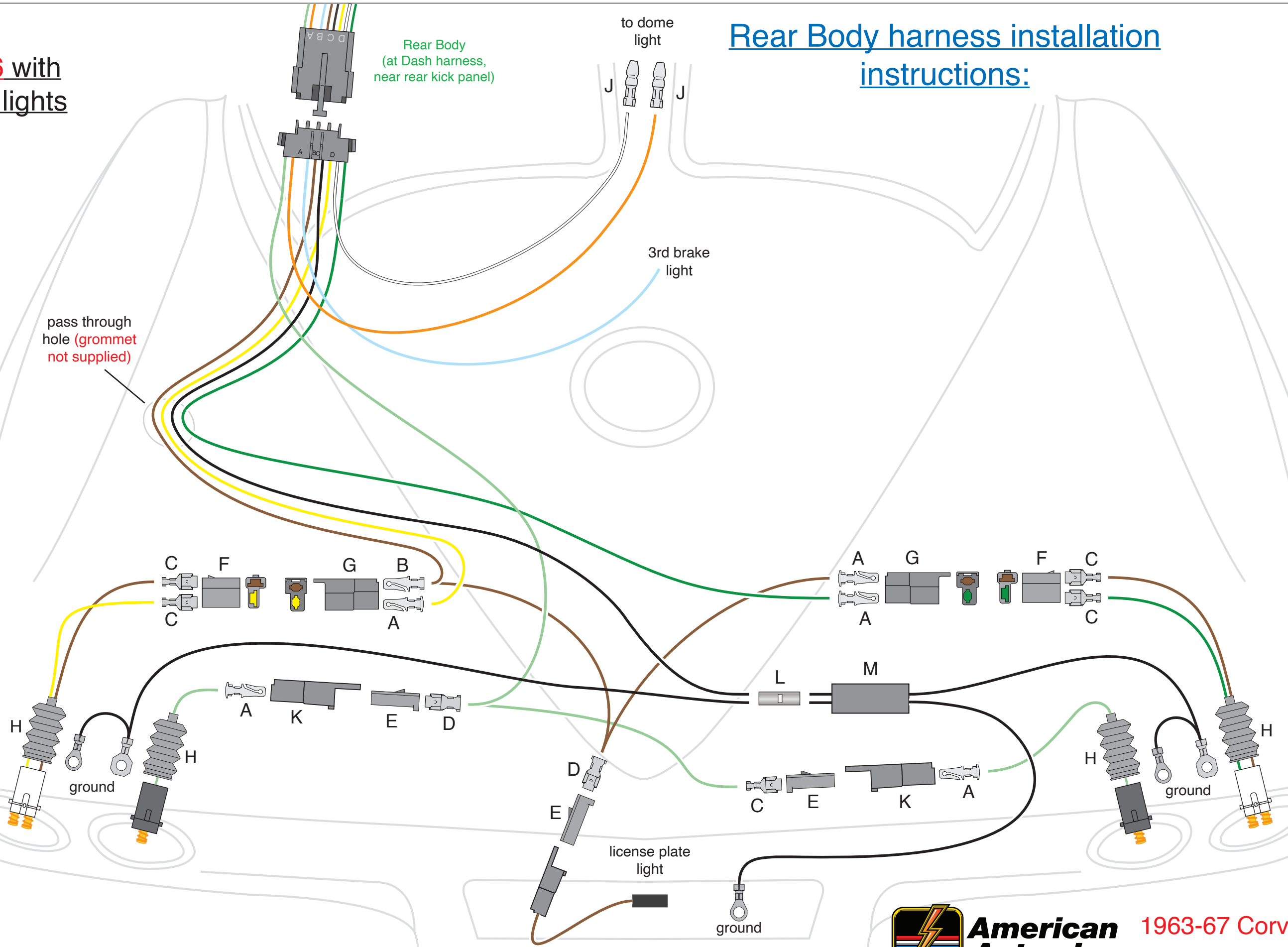

American Autowire

www.americanautowire.com 856-933-0801

1963-67 Corvette Classic Update Series

510612 92973565 Rev 2.1 12/17/2024

1967

Rear Body harness installation instructions:

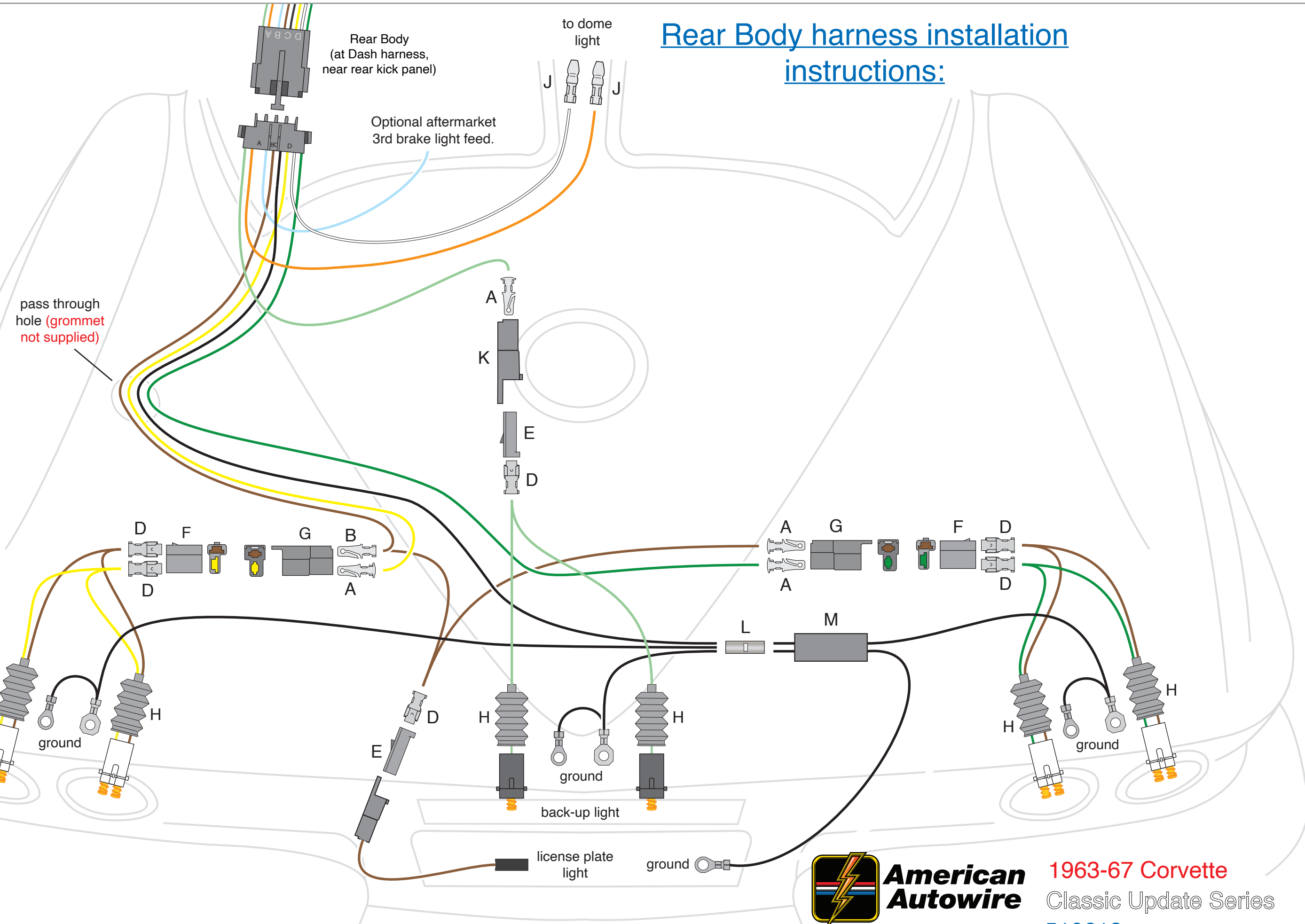

Rear Body harness installation instructions:

Rear Body
(at Dash harness,
near rear kick panel)

to parking
brake switch on console
(1967 only, see page 9 for other years)

pass through
hole (grommet
not supplied)

- Fuel Gauge Sending Unit Ground
- Fuel Gauge Sending Unit keyed 12V (+) feed
(small pin connector, used for factory sending unit only)
- Fuel Gauge Sending Unit Signal Wire
(large pin connector)

Front Light harness installation instructions:

Shown below, are the supplied misc. terminals and plastic connector bodies, that will be used to complete your Front Light harness connections. They are itemized and referred to on this page, just as they are on the following pages of this Front Light instruction set.

A  (56 series single female terminal, 10 pcs.)

B  (56 series double female terminal, 2 pcs.)

C  (56 series 3-way female conn, 2 pcs.)

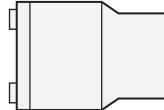
D  (terminal cover, 4 pcs.)

E  (female terminal, right angle, 5 pcs.)

F  (56 series 2-way female conn, 2 pcs.)

G  (56 series 3-way female conn, 2 pcs.)

H  (56 series single male terminal, 10 pcs.)

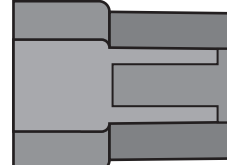
J  (56 series 3-way male conn, 2 pcs.)

K  (56 series single female connector, 2 pcs.)

L  Brake Fluid Level Warning

Front Light harness installation instructions:

Headlight Extension harness 510620

NOTE: If you have a 1963 car with original fiberglass H/L buckets, all 22 inches of the loom will be used "as-is". If your 1963-67 car has metal H/L buckets, cut the loom down and use about 10 inches of it. The 1963 fiberglass buckets also utilized a grommet. That grommet **is not included** in this kit. The cars with the metal buckets did not use any type of grommet.

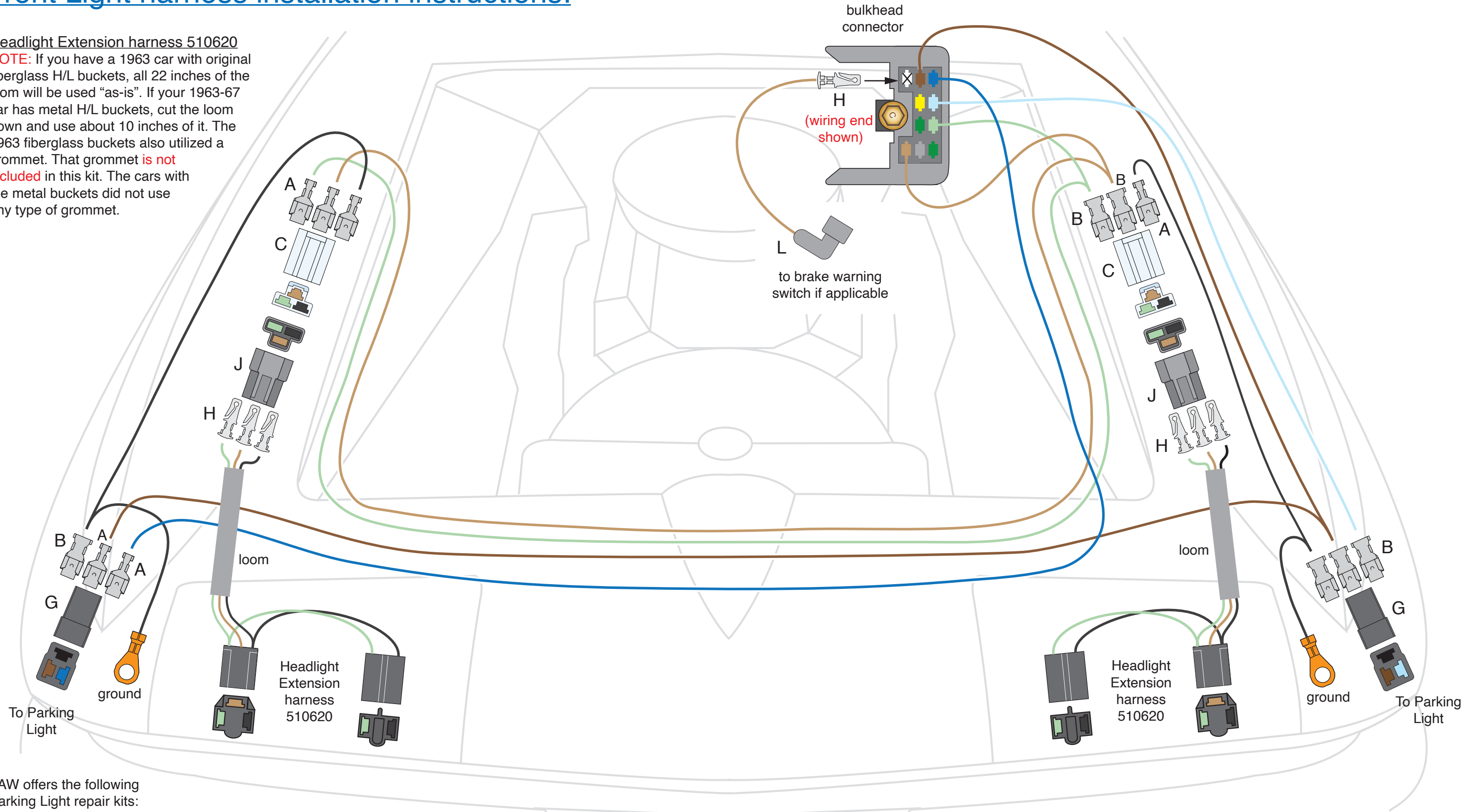

AAW offers the following Parking Light repair kits:

- 40059 (1963-66)
- 40060 (1967)



**American
Autowire**

www.americanautowire.com 856-933-0801

1963-67 Corvette
Classic Update Series





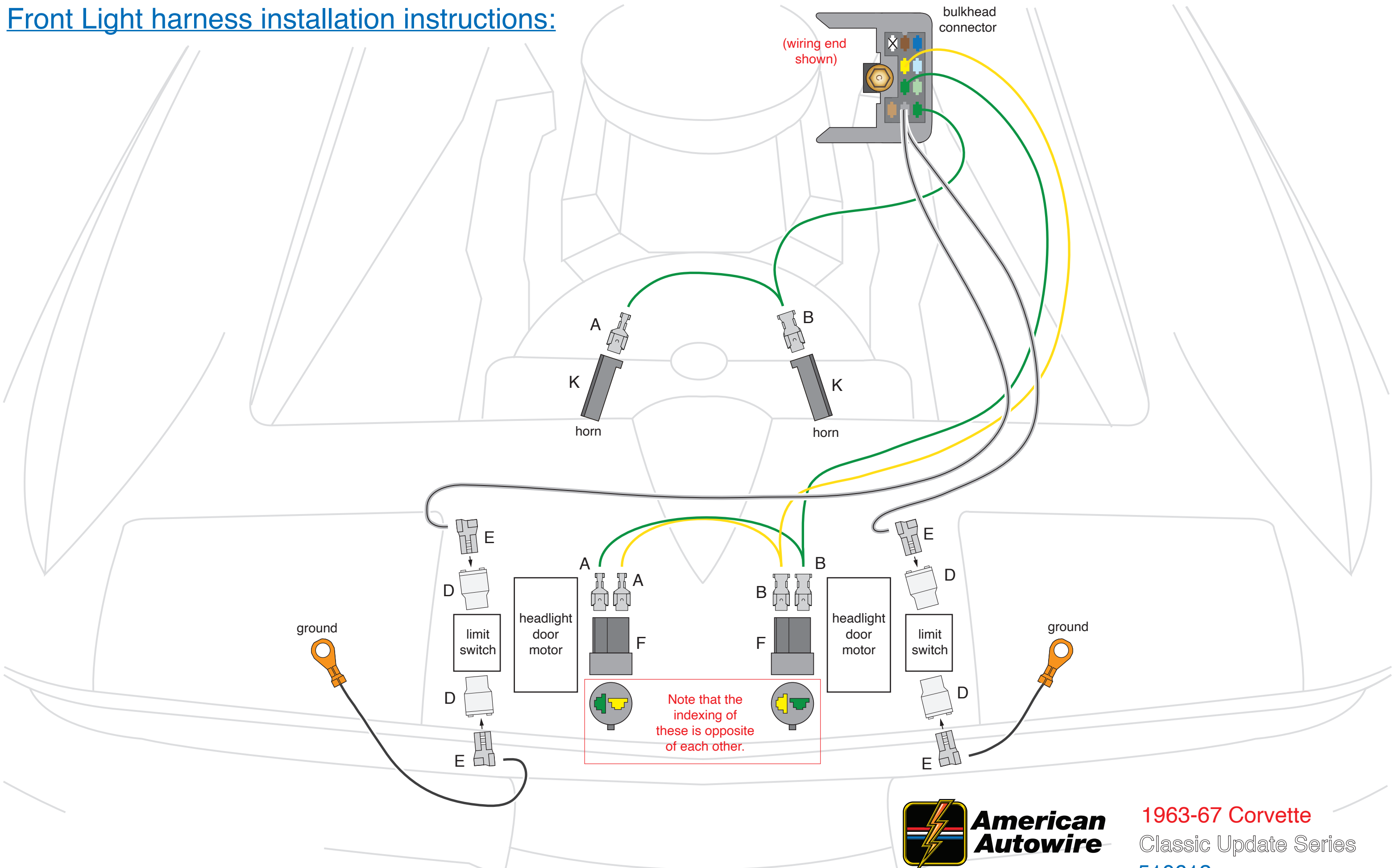





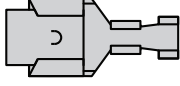
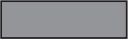
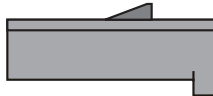
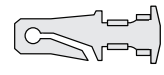

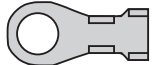

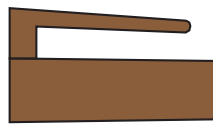

510612 92973565 Rev 2.1 12/17/2024

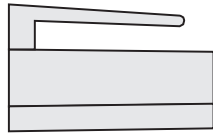
Front Light harness installation instructions:

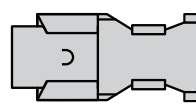

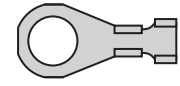
Engine harness installation instructions:

Shown below, are the supplied misc. terminals, sleeves, plastic connector bodies and wires, that will be used to complete your Engine harness connections. They are itemized and referred to on this page, just as they are on the following pages of this Engine instruction set.

A		(56 series single female terminal, 8 pcs.)	M		(small rubber sleeve, 3 pcs.)	
B		(56 series single female connector, 2 pcs.)	N		(56 series single male terminal, 3 pcs.)	
C		(56 series single female connector, 2 pcs.)	P		(56 series 1-way male conn, 1 pc.)	
E		(small ring terminal for larger gauge wire, 1 pc.)	R		(56 series single female connector, 2 pcs.)	
F		(large rubber sleeve, 2 pcs.)	S		ELECTRIC CHOKE	
H		(56 series single female connector, 2 pcs.)	T		STARTER SOLENOID - R	
J		(56 series single female connector, 2 pcs.)	U		ALTERNATOR IGN	
K		(56 series double female terminal, 4 pcs.)	V		ELECTRIC FAN	
L		(small ring terminal for smaller gauge wire, 4 pcs.)	W		STARTER SOLENOID - S	
			X		ALTERNATOR REGULATOR	
			Z		BLOWER AND WIPER MOTOR GROUNDS (2)	

Engine harness installation instructions:

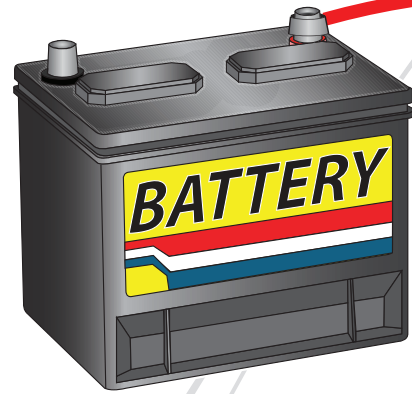

Megafuse from 510476

(BUSBAR JUMPER FROM 510476 KIT)

6 GA. RED (FROM 510476 KIT)

(MEGA FUSES, RING TERMINALS, SHRINK TUBING, AND BOOT FOUND IN 510476 KIT)

positive battery cable (not included with this kit)

HEI Distributor see detail view

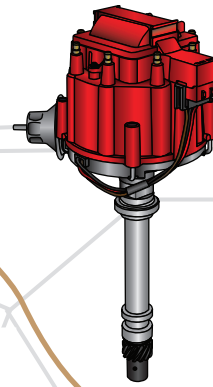

(This pink wire can also be used as keyed power source for an ignition box or aftermarket EFI harness)

to BAT (+) location on coil
to TACH (-) location on coil

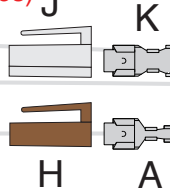

electric choke coil

see View "A" (FOR POINTS IGNITION ONLY)

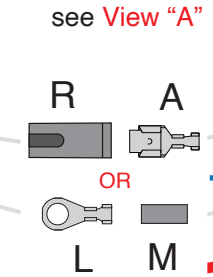

oil sending unit



temperature sending unit

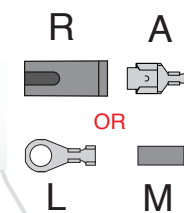

6 GA. RED (FROM 510476 KIT)

ALTERNATOR BOOT (FROM 510476 KIT)

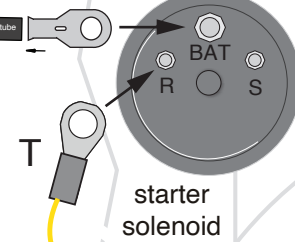

starter solenoid

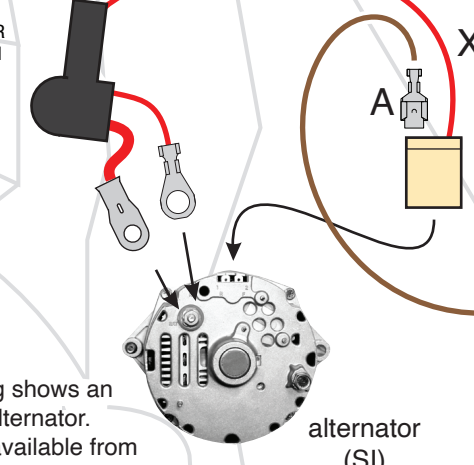

alternator (SI)

This drawing shows an SI series alternator. Adapters are available from American Autowire for other later style alternators if needed.

HEI distributor detail view:

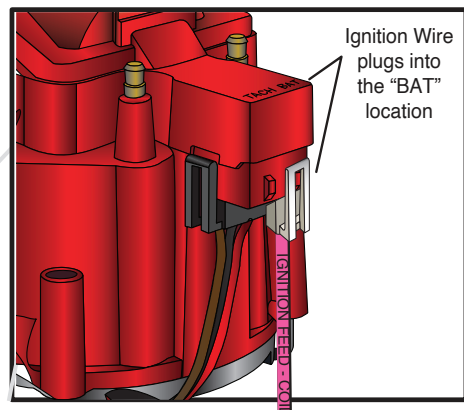

Ignition Wire plugs into the "BAT" location

white tack wire from bulkhead connector

View "A"

optional connection for points cars

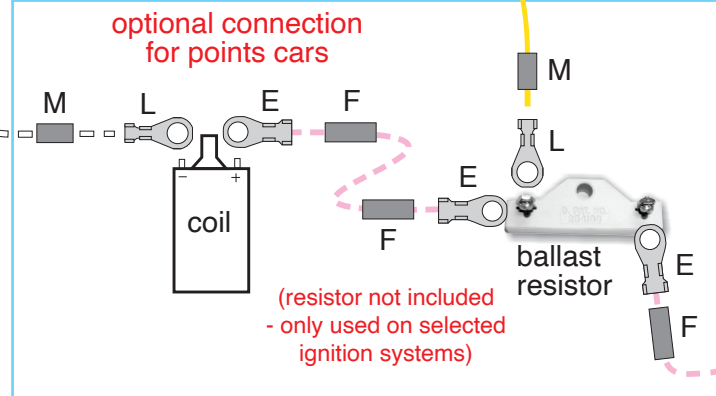

(resistor not included - only used on selected ignition systems)

pink ignition wire from bulkhead connector

Keyed (12v+) Cooling Fan Relay Trigger Wire (connect to a fan relay, sold separately)



American Autowire

www.americanautowire.com 856-933-0801

1963-67 Corvette Classic Update Series

510612 92973565 Rev 2.1 12/17/2024

Engine harness installation instructions:

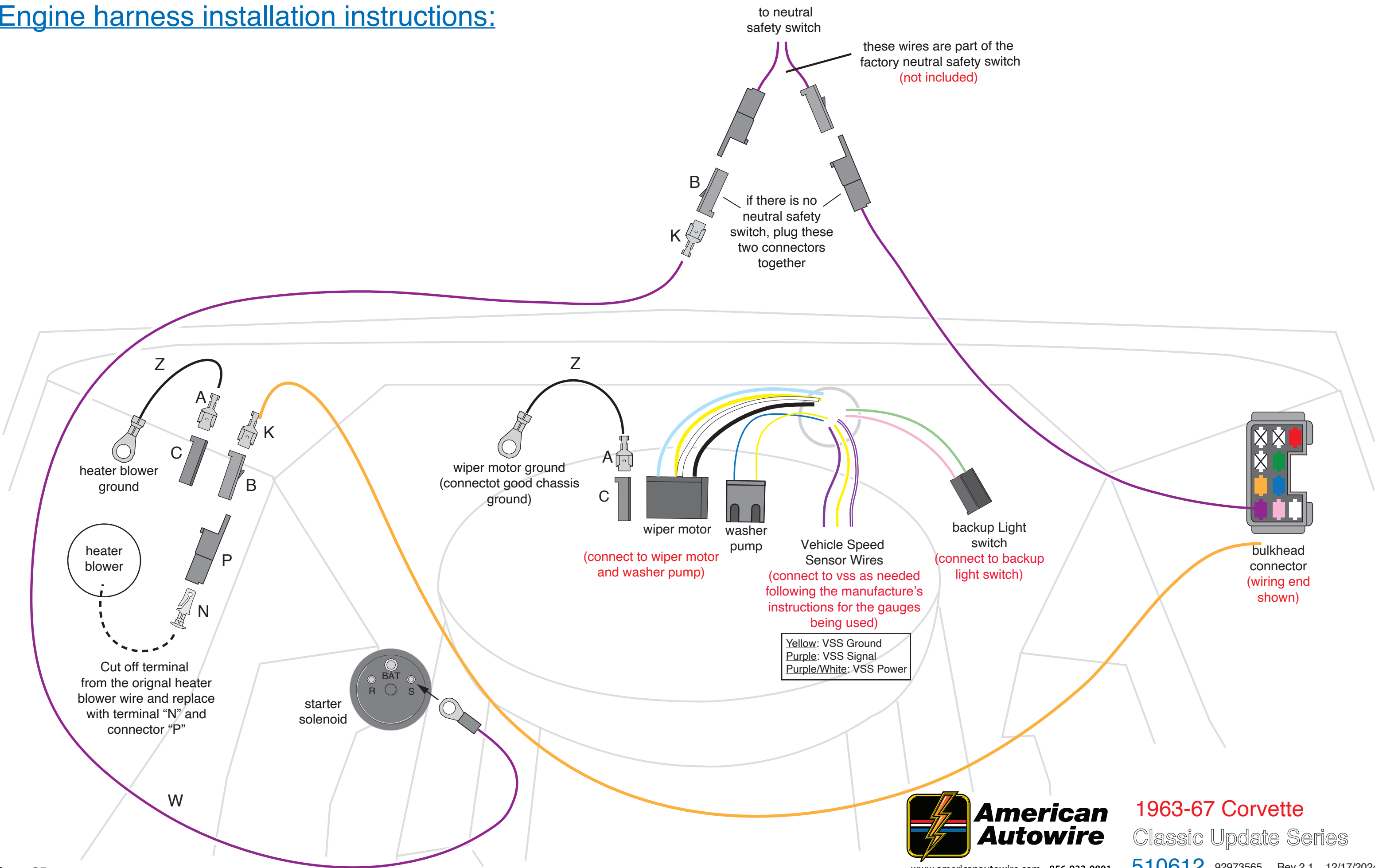

STEP 3: RECONNECT YOUR BATTERY:

When you have completed the installation and are ready to reconnect the battery, make sure that the following electrical system grounds are in place:

- A. Battery is grounded to the ENGINE BLOCK.
- B. Battery is grounded to the frame.
- C. Engine block is grounded to the frame.
- D. Body is grounded to the frame.

STEP 4: CHECK ALL ELECTRICAL FUNCTIONS:

Any non-functioning items should be checked for proper installation. Any problems with your wiring and electrical circuit functions, should be addressed to American Autowire Systems, Inc. as soon as possible, to avoid any warranty problems.

If you have any questions concerning this or any of our products, please feel free to call us at 1-856-933-0801.

Fuse Box lid

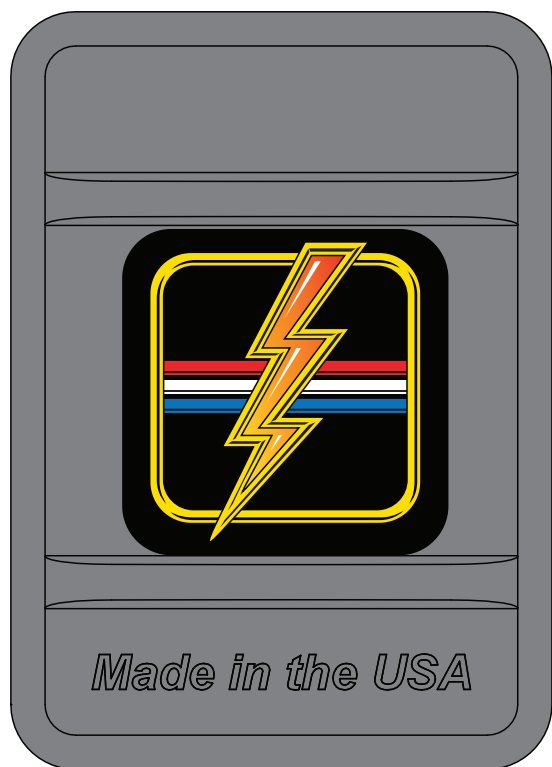

Fuse label on inside of Fuse Box lid

Batt - Spare 30A - BAT	1	9	Wiper 20A - ACC
Clock/Radio 15A - BAT	2	10	Heat/AC 30A - ACC
Power Seat 30A - BAT	3	11	Radio 10A - ACC
Park Lights 15A - BAT	4	12	Engine Fan 30A - ACC
Power Locks 15A - BAT	5	13	Turn 15A - IGN
Stop/Courtesy 15A - BAT	6	14	Gauges, B/U 10A - IGN
Hazard 15A - BAT	7	15	Elec. Choke 15A - IGN
Pwr. Window 30A - IGN	8	16	Fuel Pump 20A - IGN

Fuse Values and Locations

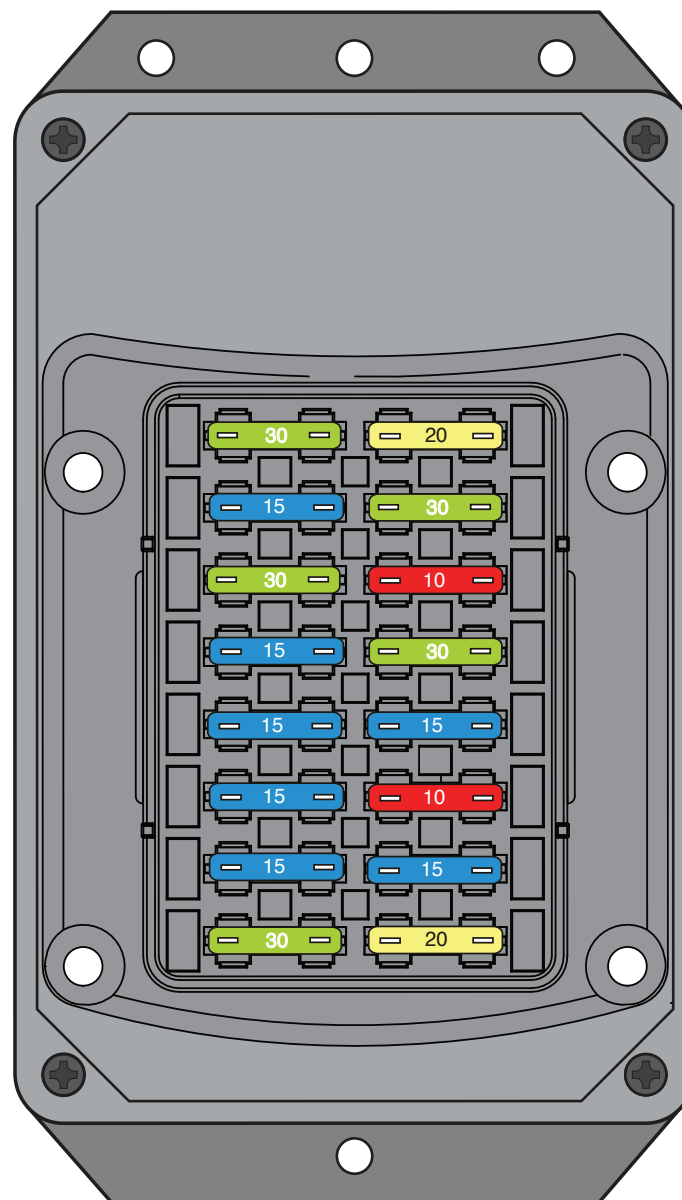

Fuse/Circuit table

Fuse #	Fuse Block Cover Label	Fuse Rating	Description
1	Bat-Spare	30A	Battery feed spare
2	Clock - Bat	15A	Battery feed for a Clock and a Radio.
3	Power Seats	30A	Battery feed for optional Power Seats.
4	Park Lights	15A	Battery feed to Park Lights
5	Power Locks	15A	Battery feed to Power Locks
6	Stop / Courtesy	15A	Battery feed for Brake Lights and Courtesy Lights.
7	Hazard	15A	Battery feed for optional Hazard Lights and optional battery feed.
8	Power Window	30A	Ignition feed for optional Power Windows.
9	Wiper	20A	12V Accessory feed for Wiper/Washer system.
10	Heat / AC	30A	12V Accessory feed for Heater/AC System.
11	Radio	10A	12V Accessory "on-off" feed to Radio.
12	Engine Fan	30A	12V Accessory for an optional Electric Fan System, Relay key-on trigger
13	Turn	15A	Ignition feed for the Turn Signals.
14	Gauges, B/U	10A	Ignition feed for Dash Gauges/Warning Lights, Back Up Lights
15	Electric Choke	15A	Ignition feed for an Electric Choke, ECM Ignition Feed
16	Fuel Pump	20A	Ignition feed for an Electric Fuel Pump

THIS PAGE INTENTIONALLY
LEFT BLANK

